

VEICHI

Manual

Version V1.1

AC90 Tension Control Frequency Inverter



Version: YEAR2015, V1.1

Shenzhen Veichi Electric Co., Ltd all right reserved. No copy permit. No notify if any modification

More information in compay web: <http://www.veichi.com>

VEICHI

Shenzhen Veichi Electric CO., LTD

3rd Floor, Block C, Wentao Science and Technology Park, Shiyan Yingrenshi
Community, Baoan District, Shenzhen City, China.

http: [//www.veichi.com](http://www.veichi.com)

Tel: +86-755-29685610 +86-755-29685611 +86-755-29685612

Fax: +86-755-29685615

Zip: 518108

Mail: veichi@veichi.com

Foreword

Thanks for using AC90 tension control frequency inverter produced by Shenzhen Veichi Electric Co.,Ltd..

AC90 tension control frequency inverter is a special high-performance vector tension control inverter developed by our company recently. It adopts advanced torque mode open loop tension control technology. It is not only an international leader in motor control performance, it also combines tension control industry characteristics, which further strengthened the product reliability, stability and ease of debugging, can to better meet the demand in the field of tension control.

This product is to keep constant tension by the output torque control and automatic roll diameter calculation. The system does not need to install a tension sensor, no need to feedback of the external signal of the current position, or the tension. It is able to complete the tension control even without need to install speed feedback rotary encoder in most applications.

To meet the needs of different customers, the product provides two basic control modes. Control modes including:

1: Speed control mode

Inverter controls the speed of the motor by controlling the output frequency. The output torque of the motor is decided by the load side, but will be limited in the maximum output torque. It is applicable to all types of speed purposes.

2: Torque control mode

The target of the inverter is to control the motor output torque. The motor speed is decided by the load side, but will be limited in the setting frequency. In this mode, the user can set the tension value, and make tension open-loop control coming true through the inverter diameter calculation function.

In tension open-loop control, roll diameter calculation is a very important part. Inverter has three roll diameter calculation methods:

A: Linear speed method.

$$v = \frac{\omega * r}{k}$$

v means linear speed of traction side; ω means The angular velocity of the rotation of the motor; k means mechanical reduction ratio; r means winding roll diameter.

B: Thickness calculation method.

Accumulate the diameter according to the material thickness and cycles of the roll rotation to gain the roll diameter.

C: Time calculation method

Time integral method needs the time from empty roll to full roll, torque for empty roll and torque for full roll. Inverter will increase torque giving value according to the change of the roll diameter and time.

AC90 tension control inverter can completely replace the torque motors, DC motors, tension controller and be independent tension control system, which makes the control system more concise, easier to maintain and with better tension control performance. It is suitable for application to paper, paper processing, printing and dyeing, packaging, wire and cable, optical fiber cable, adhesive tapes, textile, leather, metal foil processing, fibers, rubber and other industries.

Contents

Chapter 1 Overview	1
1.1 Safety requirement and cautions.....	1
1.2 Technical criterion	4
Chapter 2 Before Use	6
2.1 Purchase inspection.....	6
2.2 Nameplate	6
2.3 Standard models and rated parameters.....	7
Chapter 3 Installation and Wiring	8
3.1 Safety Precautions.....	8
3.2 Treatment for inverter after longtime store	9
3.3 Inverter stable running environment.....	9
3.4 EMI Protection.....	10
3.5 Machinery installation.....	13
3.6 Electric installation.....	20
Chapter 4 Basic Operation and Trial Run	34
4.1 Safety Precautions.....	34
4.2 Keyboard layout and functions specification.....	35
4.3 Basic operation.....	37
4.4 Trial run.....	41
Chapter 5 Fault Diagnoses and Processing	50
5.1 Fault types.....	50
5.2 Fault information and details	50
5.3 Fault diagnoses process	54
Chapter 6 Periodic Overhaul and Maintenance	60
6.1 Safety Precautions.....	60
6.2 Overhaul.....	60
6.3 Maintenance.....	62
Chapter 7 Peripheral Equipments and Options	65
7.1 Safety Precautions.....	65
7.2 Peripheral equipments.....	65
7.3 The use of peripheral equipments	67
Chapter 8 Quality Guarantee	70
8.1 Guarantee time and range.....	70
8.2 Liability exemption	70
8.3 Product application	70
Chapter 9 Function Parameter Specification	71
9.1 Basic parameters.....	71
9.2 Operation control parameter.....	80
9.3 Switch quantity terminal parameters.....	86
9.4 Analog terminal parameters	96
9.5 Keyboard and display parameters.....	100

9.6 Motor parameters.....	103
9.7 VC control parameter.....	105
9.8 V/F control parameters	107
9.9 Malfunction and protection parameters	114
9.10 Machine malfunction code table	117
9.11 PID parameters.....	125
9.12 Multi-step, PLC function and swing frequency parameters	131
9.13 Communication control function parameters	132
Chapter 10 Appendix.....	145
10.1 Appendix 1: Function parameter table	145
10.2 Appendix 2: RS485 communication protocol.....	179
10.3 Appendix 3: PG card manual	186

Chapter 1 Overview





Thanks for using AC90 tension control frequency inverter produced by Shenzhen Veichi Electric Co.,Ltd..This manual tells you how to use it perfectly. Please read this manual carefully and fully understand the safety requirement and cautions before use (installation, wiring, operation, maintain, checking, and etc...).

1.1 Safety requirement and cautions

Pls do totally understand this part before using the inverter.

Warning signs and meanings

This manual has used belowing signs that mean there is an important part of security. While observing against the rules, there is danger of injury even death or machine system damage.

	<p>Danger: Wrong operation may cause death or large accident.</p>
	<p>Warning: Wrong operation may cause death or large accident.</p>
	<p>Caution: Wrong operation may cause minor wound.</p>
	<p>Important: Wrong operation may cause the inverter and other machine system damage</p>

Warning signs position



Drawing 1: Warning positions on crust of AC90 series inverter



Operation requirement

Only Professional trained person are allowed to operate the equipment such as installation, wiring, running, maintain and etc. "Professional trained person" in this manual means the workers on this product must experience professional skill train, must be familiar with installation, wiring, running and maintain and can rightly deal with emergency cases in use.



Safety guidance

Safety regulations and warning signs come for your security. They are measures to prevent the operator and machine system from damage. Pls carefully read this manual before using and strictly observe the regulations and warning signs while operating. Safety regulations and warning signs are classified into: routine regulation, transport and store regulation, installation and wiring regulation, running regulation, maintenance regulation, dismantlement and disposal regulation.

● Routine regulation

	<ul style="list-style-type: none"> ● This product carries dangerous voltage and controls driver machine with potential danger. If you don't abide by the regulations or requirements in this manual, there is danger of body injury even death and machine system damage. ● Only qualified personnels are allowed to operate the equipment.this product. Before using, the operator must be familiar with all safety specifications and operation regulations in this manual. Safe and stable work of the product is based on right operation and maintenance. ● Do not wire while the power is conneted. Otherwise, there is danger of death for electric shock. Before wiring, inspection, maintenance, please cut power supply of all related equipments and ensure mains DC voltage in safe range. And please operate it after 5 mins.
	<ul style="list-style-type: none"> ● Away from children and public. ● Only used in application fields as maker stated. No use in equipments related to special fields such as emergency, succor, ship, medical treatment, avigation, nuclear and etc. ● Unauthorized alteration or use of accessories which are not sold or recommended by the maker may cause faults.
	<ul style="list-style-type: none"> ● Please make sure this manual is in the final user'hand before using. ● Before installation and debugging pls carefully read and totally understand these safety regulation and warning signs.

● Transport and store regulation

	<ul style="list-style-type: none"> ● Correct transport, store, installation and careful operation an maintenance are important for inverter safe operation.
	<ul style="list-style-type: none"> ● In transport and store process, make sure the inverter is free from impact and vibration. It must be stored where is dry without corrosive air and conductive dust, and the temperature must be lower than 60°C.

● Installation and wiring regulation

	<ul style="list-style-type: none"> ● Only professional trained person can operate it. ● Power wire, motor wire and control wire should be all connected firmly. Earth must be reliable and earth resistance must be lower than 10Ω. ● Before opening the inverter, please disconnect all related equipment power supply and make sure the mains DC voltage is in safe range and operate after 5mins. ● Human body electrostatic will damage inner sensitive components seriously. Before operation, please follow ESD measures. Otherwise, there is danger of iverter damage. ● Inverter output voltage is pulse wave. If components such as capacitor which improves power factor and pressure-sensitive resistance for anti-thunder and so on are installed at the output
---	--

	<p>side, please dismantle them or change to input side.</p> <ul style="list-style-type: none"> ● No switch components such as breaker and contactor at the output side. (If there must be one, please make sure the output current is 0 while the switch acting).
	<ul style="list-style-type: none"> ● The power supply cable and motor cable specifications must satisfy all conditions in table 3-7 3-8 .

● **Run regulation**

	<ul style="list-style-type: none"> ● Inverter runs at high voltage. So dangerous voltage is in some components inevitably. ● No matter where the fault is, there is danger of serious accident, even human body injury what means dangerous malfunction possibility. So there must be additional external prevent measures or other safety devices, such as independent current limiting switch, machinery fence and so on.
---	---

● **Maintenance regulation**

	<ul style="list-style-type: none"> ● Only Shenzhen Veichi Electric co., ltd service department or its authorized service center or professional person trained and authorized by Veichi can maintain the products. They should be very familiar with the safety warning and operation gist in this manual. ● Any defective components must be changed in time. ● Before opening the inverter to repair please cut power supply of all related equipments and ensure mains DC voltage in safe range. And please do operation after 5 mins.
---	--

● **Dismantlement and disposal regulation**

	<ul style="list-style-type: none"> ● Packing case can be reused. Please keep them and reuse or send back to maker. ● Dismantled metal components are retractable and can be reused. ● Some components such as electrolytic capacitor are harmful to environment. Please dispose according to environmental protection departments.
---	---

1.2 Technic criterion

Items		Criterion
Power input	Voltage,frequency	Single phase220V 50/60Hz Three phase380V 50/60Hz Three phase220V 50/60Hz Three phase660V 50/60Hz Three phase1140V 50/60Hz
	Allowable fluctuations	Voltage:320V~440V; voltage unbalance rate:<3%; Frequency:±5% aberration rate: as IEC61800-2 required
	Inrush current	Lower than rated current
	Power factor	≥0.94(with DC reactor)
	Efficiency	≥96%
Output	Output voltage	Output under rated condition:3 phase, 0~input voltage, inaccuracy<5%
	Output frequency range	G type:0-320Hz
	Output frequency accuracy	Max frequency ±0.5%
	Overload capacity	G type:150% rated current/1 min,180% rated current/10s,200% rated current/0.5s
Main Control performance	Motor control mode	VC without PG, VC with PG, V/F without PG, V/F with PG
	Modulate mode	Optimized SVPWM mode
	Carrier frequency	0.6~15.0kHz,randomized carrier-wave
	Speed range	VC without PG: rated load 1:100 VC with PG: rated load 1:1000
	Steady speed accuracy	VC without PG: ≤1% rated synchronized speed VC with PG: ≤0.02% rated synchronized speed
	Starting torque	Flux VC without PG: when 0.5Hz, 180% rated torque Flux VC with PG: when 0Hz, 200% rated torque
	Torque response	Flux VC without PG: ≤20ms Flux VC with PG: ≤10ms
Product basic functions	Tension control	Tension setting calculation;Tension tape calculation
	Roll diameter calculation	Linear speed calculation method;Thickness calculation method; Time integral calculation method
	Torque control	Torque setting calculation; Torque ACC/DEC time; Torque compensation; Speed limit
	Speed control	Frequency setting; ACC/DEC time setting; Run direction setting; Speed setting; Torque setting
	Motor parameter study	Rotate auto studay; Static auto studay
	Auto voltage adjust	Auto keep stable output voltage while the net voltage waves
	Auto energy saving run	Auto output best voltage according to actual load need to save energy
	Auto limit current	Auto limit current in running to prevent

	Frequency set channels	Keyboard digital set, keyboard potentiometer, analog voltage terminal VS1/VS2, analog current terminal AS, communication given and multi channels terminal selection, master-slave channels combination.	
	Feedback input channel	Voltage terminal VS1/VS2, current terminal AS, communication given, pulse input PUL.	
	Running command channel	Operation panel given, external terminal given, communication given.	
	Input command signal	Start, stop, FOR/REV, JOG, multi-step speed, free stop, reset, Acceleration/Deceleration time selection, frequency set channel selection, exterior fault alarm.	
	Exterior output signal	One relay output, two collector output, 0~10V output, 4~20mA output, frequency pulse output.	
Protection function		Overvoltage, undervoltage, current limit, overcurrent, overload, electric thermal relay, overheat, overvoltage stall, data protection.	
Keyboard display	LED display	Single file 4 digital tube display	Can monitor one state variable
		Two file 4 digital tube display	Can monitor two state variables
	Parameter copy	Can upload or download function code information of inverter to realize fast parameter copy.	
	State monitor	Output frequency, given frequency, output current, input voltage, output voltage, motor speed, PID feedback, PID given value, module temperature, input/output terminal condition.	
Fault alarm	Over-voltage, under-voltage, over-current, short circuit, open phase, overload, overheat, over-voltage speed lost, current limit, or data protection is destroyed; Fault running state; Fault history.		
Environment	Install place	Indoor, altitude $\leq 1000\text{m}$, no corrosive air or direct sunshine	
	Temperature, humidity	-10 ~ +40°C (hanging type)	
		-10 ~ +45°C (cabinet type)	
		20%—90%RH (no condensation)	
	Vibration	Under 20Hz $\leq 0.5\text{g}$	
	Store temperature	-25—+65°C	
	Installation	Hanging type, cabinet type	
Protection	IP20		
Cooling mode	Forced cooling		

Table 1-1: Technic criterion

Chapter 2 Before Use

2.1 Purchase inspection

Pls check whether any package is damaged while receiving the product you ordered. If the package is ok, pls open it and check the inverter. If damage caused in transport, it is not duty of Veichi company. But please contact Veichi or the transport company immediately.

After checking the product, please also check if the model is the one you ordered. The model of the product is on the nameplate "MODEL" column. If the model is not in accordance with your need, please contact the agent or the sales departments in our company.

2.2 Nameplate

Nameplate position and content

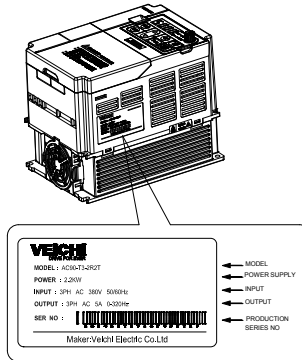

Drawing 2-1: AC90 series inverter nameplate position

Model explainatio

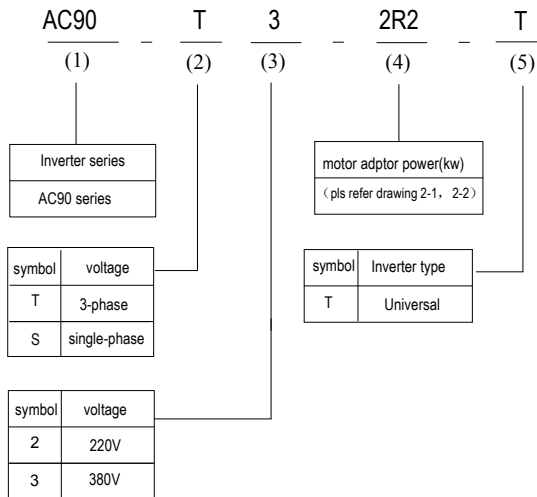

Drawing 2-2: AC90 series inverter nameplate meaning and naming rules

2.3 Standard models and rated parameters

Single phase 220V

Model	Max adaptive motor	Rated current	Model	Max adaptive motor	Rated current
AC90-S2-R40T	0.4kW	2.5A	AC90-S2-1R5T	1.5kW	7A
AC90-S2-R75T	0.75kW	4A	AC90-S2-2R2T	2.2kW	10A

Table 2-1: AC90 single phase 220V series inverter models and rated parameters

Three phase 380V

Model	Max adaptive motor	Rated current	Model	Max adaptive motor	Rated current
AC90-T3-R75T	0.75kW	2.5A	AC90-T3-110T	110kW	210A
AC90-T3-1R5T	1.5kW	3.7A	AC90-T3-132T	132kW	250A
AC90-T3-2R2T	2.2kW	5A	AC90-T3-160T	160kW	310A
AC90-T3-004T	4kW	10A	AC90-T3-185T	185kW	340A
AC90-T3-5R5T	5.5kW	13A	AC90-T3-200T	200kW	380A
AC90-T3-7R5T	7.5kW	17A	AC90-T3-220T	220kW	415A
AC90-T3-011T	11kW	25A	AC90-T3-250T	250kW	470A
AC90-T3-015T	15kW	32A	AC90-T3-280T	280kW	510A
AC90-T3-018T	18.5kW	38A	AC90-T3-315T	315kW	600A
AC90-T3-022T	22kW	45A	AC90-T3-355T	355kW	670A
AC90-T3-030T	30kW	60A	AC90-T3-400T	400kW	750A
AC90-T3-037T	37kW	75A	AC90-T3-450T	450kW	800A
AC90-BT3-045T	45kW	90A	AC90-T3-500T	500kW	860A
AC90-T3-055T	55kW	110A	AC90-T3-560T	560kW	990A
AC90-T3-075T	75kW	150A	AC90-T3-630T	630kW	1100A
AC90-T3-090T	90kW	180A	AC90-T3-700T	700kW	1260A



Table 2-2: AC90 three phase 380V series inverter models and rated parameters

Chapter 3 Installation and Wiring

3.1 Safety Precautions

This chapter explains the warnings for safe use and stable running of the product.

Cautions in use

	<ul style="list-style-type: none"> ● While stall the inverter in the closed cabinet, please build in cooling fan, air-condition or other cooling equipments to ensure the temperature at the air-in port below 40°C. So that the inverter can work safely and reliably.
	<ul style="list-style-type: none"> ● While installing, please use cloth or paper cover the inverter to prevent metal dust, oil, water and others. And remove it carefully after working. ● While operation, please follow the ESD regulations. Otherwise, the inverter may be damaged. ● While multi inverters are installed in the same cabinet, enough space must be left for cooling fan. ● Inverter can not work over rated range. Otherwise, the inverter may be damaged. ● While transporting the inverter, please hold the firm case. If only hold the pre-cover, there is danger of inverter main body falling, injury or inverter damage.

Cautions in use motor

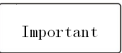
	<ul style="list-style-type: none"> ● Different motor has different max allowable running speed. Motor can not run over the max allowable running speed. ● While inverter is running at low speed, the motor auto-cool effect is seriously worse. If motor runs at low speed for long time, it will be damaged for overheat. If needed, please use special motor for inverter. ● While constant speed machinery runs at unconstant speed, there maybe sympathetic vibration. Please install vibration-proof rubber under motor rack or use jumping frequency control function. ● While using frequency inverter or working frequency power supply to drive, the torque characteristic are different. Please do confirm the torque characteristic of the equipment connected. ● The rated current of shift gear motor is different from that of standard motor. Please confirm it and choose the right frequency inverter. Moreover, please do switch the pole while the inverter input current is 0. Otherwise it may bring inverter protection or damage. ● The rated current of diving motor is higher than that of standard motor, please confirm it and choose the right inverter. ● While the wire between motor and inverter is long, the max torque of the motor will reduce for voltage drop. So please use thick cable while the distance between the motor and the inverter is long.
---	--

3.2 Treatment for inverter after longtime store

If the inverter store time is over one year, you must precharge the aluminium capacitor in the inverter again and install the inverter after the aluminium capacitor characteristic recovering. For the specific method, please follow the grads in belowing chart and give corresponding proportional voltage for every grad more than 30 mins while the inverter is no-load.

If the input voltage of one grad is at the action critical point of contactor, fan or other equipments, please increase or reduce the corresponding input voltage for the grad to avoid any component working under critical state.

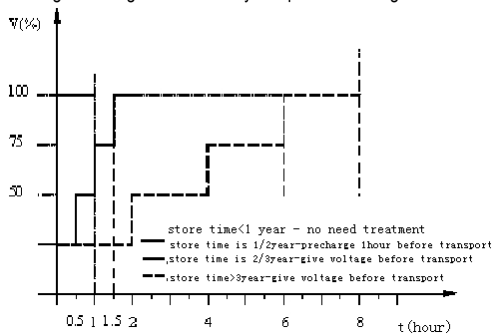

Chart 3-1: treatment for inverter after longtime store

3.3 Inverter stable running environment

Installation environment is very important to the best use of this product for long time. Pls install this product in the environment as the following chart requirement.

Environment	Requirement
Install place	Indoor without direct sunshine
Install temperature	-10 ~ +40℃ (hanging type) -10 ~ +45℃ (cabinet type)
Store temperature	-20 ~ +60℃
Humidity	<95%RH, no condensation
Surrounding	Please install the inverter in place as follows: <ul style="list-style-type: none"> ● Place without oil mist, corrosive gases, flammable gas, dust or etc. ● Place without metal dust, oil, water or etc into inverter (please do not install inverter on flammable material such as food and etc). ● Place without radioactive material or flammable material. ● Place without poisonous gases or liquid. ● Place with very little salification erosion. ● Place without direct sunshine.
Altitude	<1000m
Vibration	<10~20Hz:9.8m/s ² <20~55Hz:5.9m/s ²
Installation and cooling	<ul style="list-style-type: none"> ● Inverter can not be installed horizontally must be installed vertically. ● Please independently install high heating equipments such as braking resistor and etc which can not be installed in the same cabinet with inverter, installed at the air-in port of the inverter is strictly prohibited.

Chart 3-1:AC90 series inverter running environment condition

- In order to improve the product stability, pls do not use the inverter where temperature changes sharply. While using in closed space such as control cabinet, please use cooling fan or air-condition to cool inverter to avoid temperature over limit range. Please also prevent inverter from freeze, too low temperature may cause components freeze fault.
- Derate according to the chart while over temperature limit.

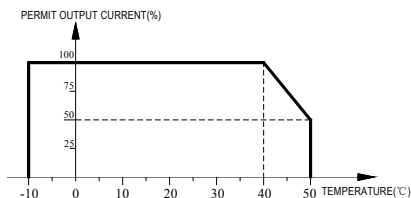

Chart 3-2:AC90 series inverter derating curve while over permit temperature temperature

- Derate according to the chart while over altitude limit.

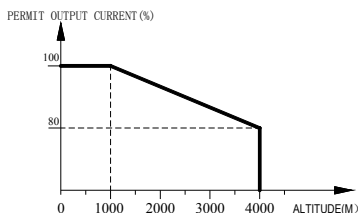



Chart 3-3:AC90 series inverter derating curve while over permit altitude

3.4 EMI Protection

The inverter is designed to be used in industrial environment with strong electromagnetic interference. Generally speaking, if the installation quality is good, it is ensured that the inverter can work safely without fault. Please install the inverter according to the following rules to ensure stable running and avoid electromagnetic interference impact.

- Ensure that all equipments in the cabinet have been connected reliably to the common Y-type earth point or earth bus with thick and short cable. The motor earth should be as close as possible. Please do not connect the motor case to the inverter earth terminal or the protective area of control system.
- Ensure that all equipments connected to the inverter have been reliably connected to the same earth net or Y-type earth point with thick and short cable.
- The conductor has better to be flat and with multi core, what has lower resistance at high frequency.
- The cutting terminal should be as soigne as possible. Unshielded wire section must be as short as possible.
- In control cable wiring, it should be as far from the power supply cable and motor cable as possible. And independent cable trough should be used. While the control cable must cross to the power supply cable or motor cable, it should be 90° vertical cross.
- Ensure that the contactor in the cabinet has wave surge suppresser. Or'R-C'damping circuit is connected to the winding of AC contactor. Voltage dependent resistor corresponding to the winding voltage is used. And freewheel diode or components such as voltage dependent resistor corresponding to the winding voltage are connected to DC contactor. It is very important while contactor, controlled by output relay of inverter, acts frequently.
- Cable connected to motor should be shielded cable or armoured cable. The two barriers are earthed reliably by cable grounding card.
- Build noise filters at the input side to reduce electromagnetic interference from other equipments at the power grid side. The noise filter should be as close to the inverter power input terminal as possible. Meantime, the filter must earth reliably as the inverter.

- Build noise filters at the output side to reduce radio interference and inductive disturbance. The noise filter must be as close to the inverter output terminal as possible. Meantime, the filter must earth reliably as the inverter.
- Anytime, control circuit wire should be shielded cable.
- Add zero phase reactor in power supply wire near inverter input terminal and add zero phase reactor in the motor wire near inverter output terminal to reduce electromagnetic interference to the inverter efficiently.
- Earthing Right and reliable earthing is the basic condition of safe and reliable running of the product. For right earthing, please read the following notice carefully.

	<ul style="list-style-type: none"> ● In order to avoid electric shock, earthing cable should be the size as electric equipment technic standard required and cable length should be as short as possible. Otherwise, inverter leakage current will cause unstable potential of the earthing terminal which is far from the earthing point, and electric shock accident will happen frequently. ● Earth terminal must be earthing. Earth resistance must be below 10Ω. Otherwise, there is danger of death.
	<ul style="list-style-type: none"> ● Please do not share earth cable with welder or other big current/pulse power equipment. Otherwise, inverter will act abnormally. ● While multi inverters are used at the same time, please do not wind the earth wire to loop-type. Otherwise, inverter will act abnormally.

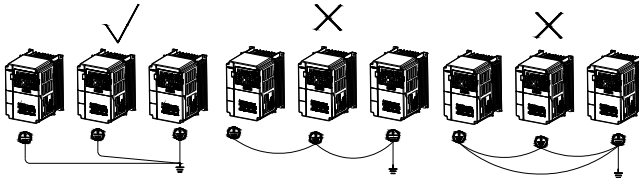

Chart 3-4: multi AC90 series inverters united earthing

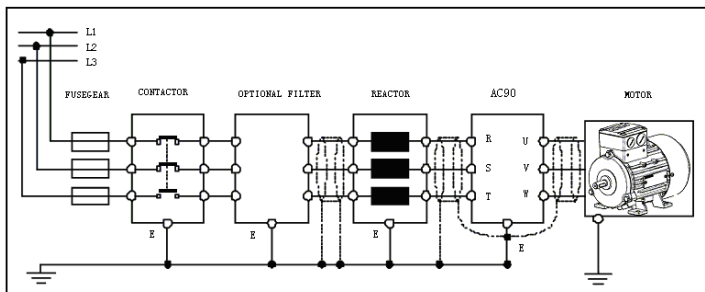

Chart 3-5: AC90 series inverter system earthing

Remark: motor must earth as close as possible. Motor case can not be connected to the inner earth terminal of the inverter. It also can not share the earth net with the control system.

Shield of inverter power cable, motor cable, control cable Cable
Shielding layer (reticulate/armoured) should be wound reliably by cable earth card and fix to inverter earth piece by bolt.
Please refer to the following chart.

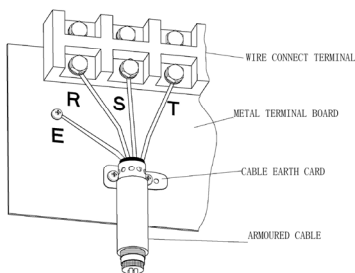

Chart 3-6: Cable earth card for cables earthing

● Corresponding relationship between inverter/motor cable length and carrier frequency.

While cable distance between inverter and motor is long (especially low frequency output), cable voltage drop will make motor torque reduce. Further more, cable HF leakage current will increase. Then inverter output current will increase, that will cause inverter over-current trip. The current detection accuracy and running stability will be impacted. Please follow as below chart to adjust carrier frequency according to the cable length. While the cable distance is over 100m, please adopt distributed capacity reduce measure (Such as "no metal conductor covers cable", "wire each phase cable apart" and so on).

Cable length	<20m	20~50m	50~100m	>100m
Carrier frequency	0.6~16kHz	0.6~8kHz	0.6~4kHz	0.6~2kHz

Chart 3-2: Corresponding relationship between inverter/motor cable length and carrier frequency

3.5 Machinery installation

Installation notice and related requirement

- AC90 inverter components

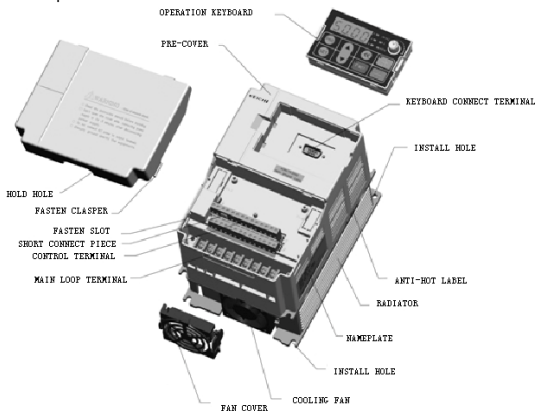

Chart 3-7: AC90 series inverter components

- Installation direction

To prevent inverter cooling effect reducing, please do install the inverter vertically.

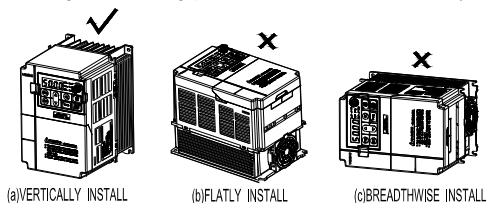

Chart 3-8: AC90 series inverter installation direction

- Installation space

Single machine installation: to ensure enough ventilation and wiring space for inverter cooling, please follow installation conditions as follows. The back of the inverter should stick to the wall. So that the surrounding air of radiator can flow freely to ensure the cooling effect.

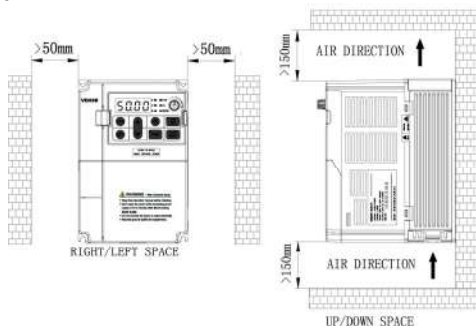

Chart 3-9: Single AC90 series inverter installation space

Multi inverters paratactic installation: while installing multi inverters in cabinet, please ensure installation space as follows.

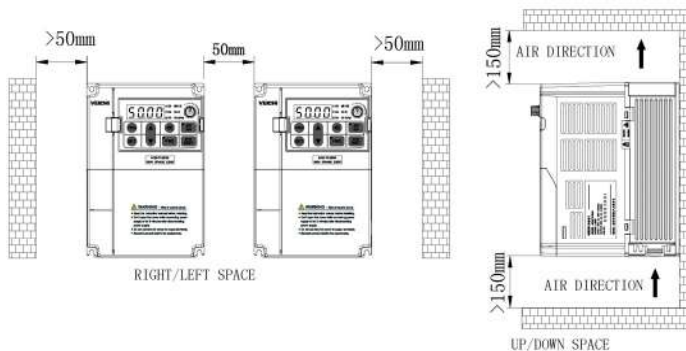
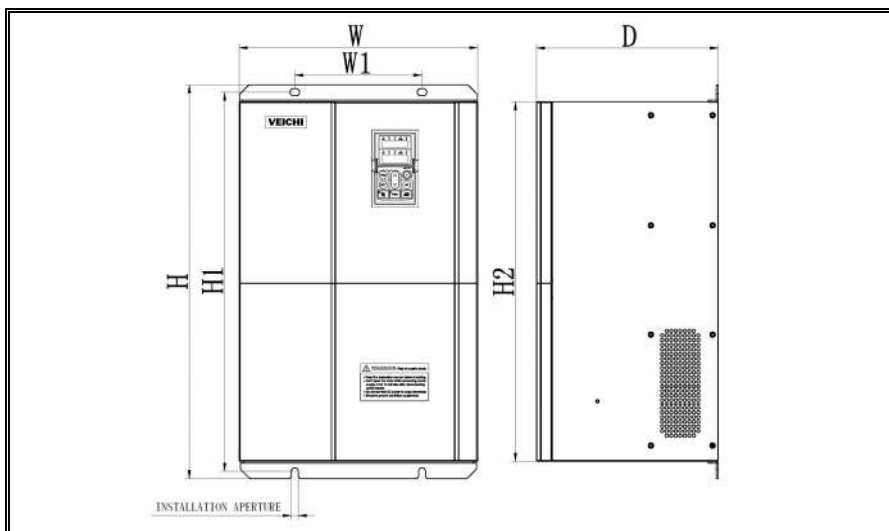

Chart 3-10: Multi AC90 series inverters paratactic installation space requirement

Dimension of inverter and keyboard

MODEL	Dimension of inverter and keyboard				Dimension of cabinet		INSTALLATION APERTURE
	W	W1	H	H1	D	D1	
AC90-S2-R40T	122	112	182	171	154.5	145	φ5
AC90-S2-R75T							
AC90-S2-1R5T							
AC90-S2-2R2T	159	147.2	246	236	157.5	148	φ5.5
AC90-T3-R75T	122	112	182	171	154.5	145	φ5
AC90-T3-1R5T							
AC90-T3-2R2T							
AC90-T3-004T	159	147.2	246	236	157.5	148	φ5.5
AC90-T3-5R5T							
AC90-T3-7R5T	195	179	291	275	167.5	158	φ7
AC90-T3-011T							



MODEL	W	W1	H	H1	H2	D	INSTALLATION APERTURE
AC90-T3-015T	255	160	434	418	390	224	φ7
AC90-T3-018T							
AC90-T3-022T	285	200	493	473	445	265	φ9
AC90-T3-030T							
AC90-T3-037T	375	200	620	597	567	286	φ11
AC90-T3-045T							
AC90-T3-055T							
AC90-T3-075T	466	300	760	735	700	320	φ11
AC90-T3-090T							

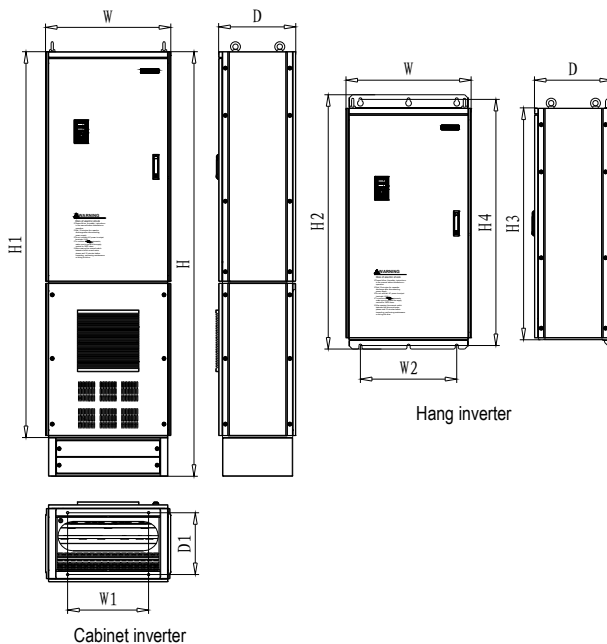

MODEL	W	W1	W2	H	H1	H2	H3	H4	D	D1	installation aperture of cabinet inverter	installation aperture of hang inverter
AC90-T3-132T	590	350	430	1800	1600	1160	1050	1123	400	320	φ11	φ14
AC90-T3-160T												
AC90-T3-185T												
AC90-T3-200T	650	420	500	2200	2000	1318	1200	1276	400	321	φ13	φ16
AC90-T3-220T												
AC90-T3-250T	750	400	600	2200	2000	1325	1200	1278	400	320	φ13	φ18
AC90-T3-280T												

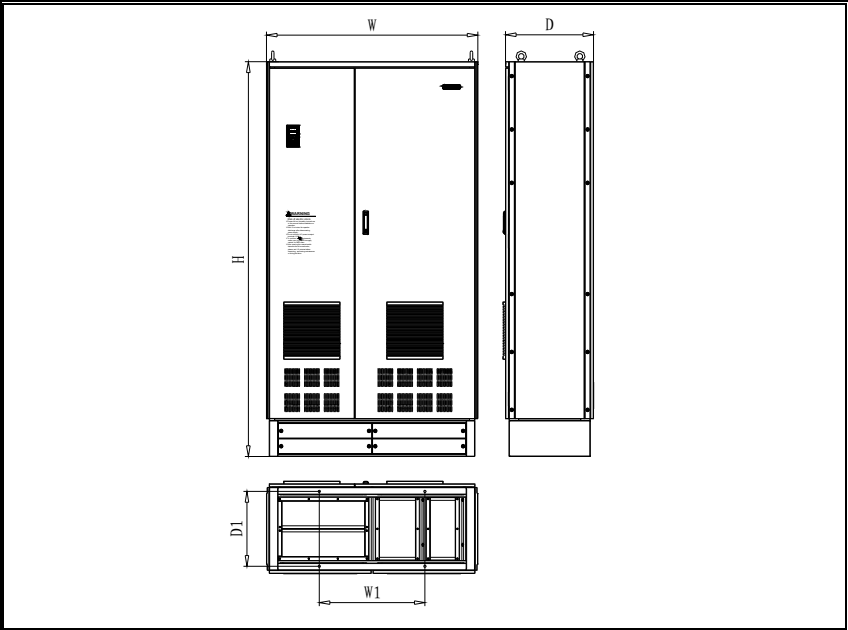

The technical drawing illustrates the AC90 series inverter from three perspectives: a front view, a side view, and a top view. The front view shows a vertical cabinet with a door on the right side, featuring a handle and a lock. Below the door are two large rectangular panels, each with a grid of smaller square components. The side view shows the depth of the cabinet, and the top view shows the width and depth of the base. Dimensions are labeled as follows: W (width), H (height), D (depth), D1 (depth of the base), and W1 (width of the base).

MODEL	W	W1	H	D1	D	INSTALLATION APERTURE
AC90-T3-315T	800	400	2200	361	450	φ13
AC90-T3-355T						
AC90-T3-400T	1200	600	2200	417	550	φ13
AC90-T3-450T						
AC90-T3-500T						
AC90-T3-560T						

Chart 3-3: AC90 series inverter dimension

Keyboard dimension

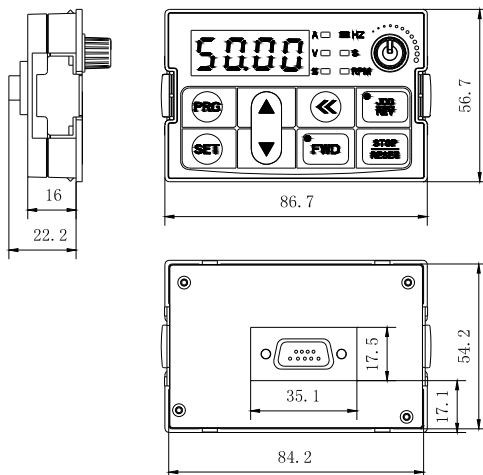

Chart 3-11:AC90 series inverter 1 line LED keyboard dimension

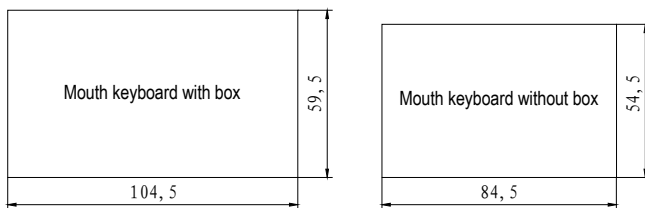

Chart 3-12:AC90 series inverter mouth for 1 line LED keyboard dimension

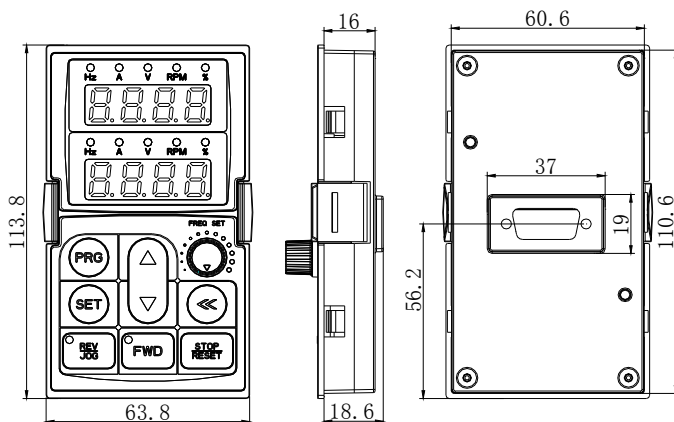

Chart 3-13:AC90 series inverter 2 line LED keyboard dimension

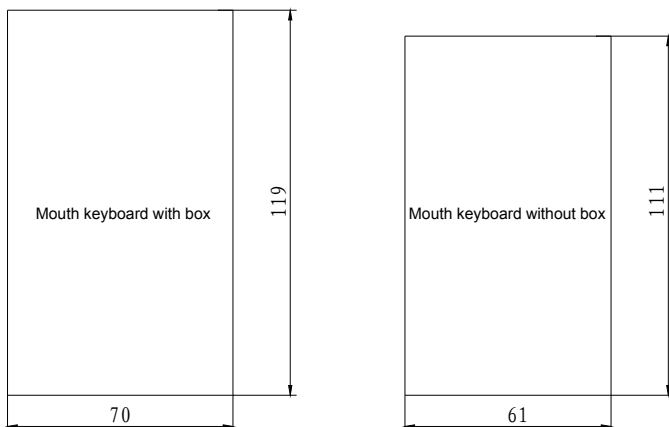
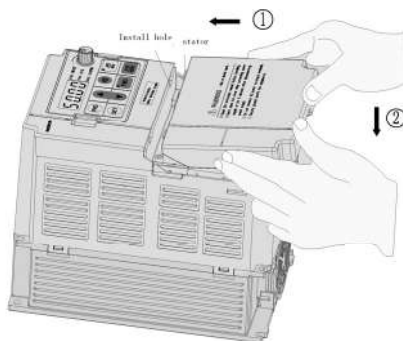

Chart 3-14:AC90 series inverter mouth for 2 line LED keyboard dimension

Dismantle and install tail-hood

Installation: First the tail-hood upwardly inclines around 15 degrees and inserts the top fixed flat into the fixed hole in the front cover. Then slightly press the tail-hood downward. While you hear "Ka", it means that the tail-hood is into the place.

Chart 3-15:AC90 series inverter tail-hood installation



Dismantlement: At the tail of the frequency inverter, there is a special dismantlement hole design. Put your finger into the hole, upwardly pull the cover with a little force until the buckle between the tail-hood and the crust tear off, and then remove the tail-hood down.

Chart 3-16:AC90 series inverter tail-hood dismantlement

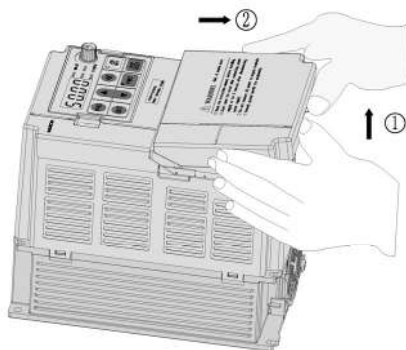

Dismantle and install keyboard

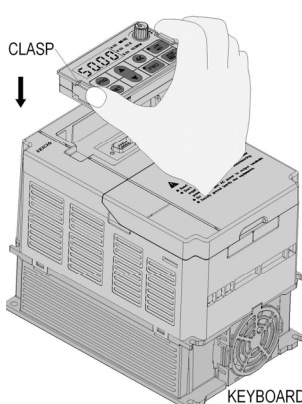

KEYBOARD INSTALLATION

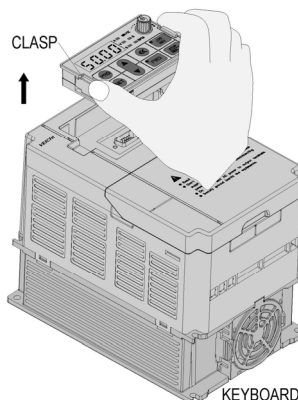



KEYBOARD DISMANTLEMENT

Chart 3-17: AC90 series inverter keyboard installation and dismantlement

3.6 Electric installation

This chapter explains the regulations that users have to obey to ensure safe use, best performance and reliable running.

Safety attention

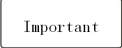
	<ul style="list-style-type: none"> ● Must earth reliably while inverter is running. Otherwise there is danger of casualty and unstable inverter performance. ● To ensure safe running, only trained professional person can do installation and wiring job. ● No operation under power connected state. Otherwise there is danger of electric shock even death. ● Before operation, please cut all related equipments power, ensure that the main circuit DC current has dropped to safe range. And please operate after 5 mins.
	<ul style="list-style-type: none"> ● Control cable, power cable and motor cable must be separated. They can not be in the same cable trough or cable rack. ● This equipment can only be used as the maker states. Please consult Veichi while using in special case.
	<ul style="list-style-type: none"> ● No insulation test for the inverter or the related cable by HV insulation test equipment. ● If the inverter or the peripheral equipment (filer, reactor and etc) needs insulation test, firstly 500V megohmmeter should be used to test the insulation resistance which should not be lower than 4MΩ.

Standard diagram

● Standard diagram

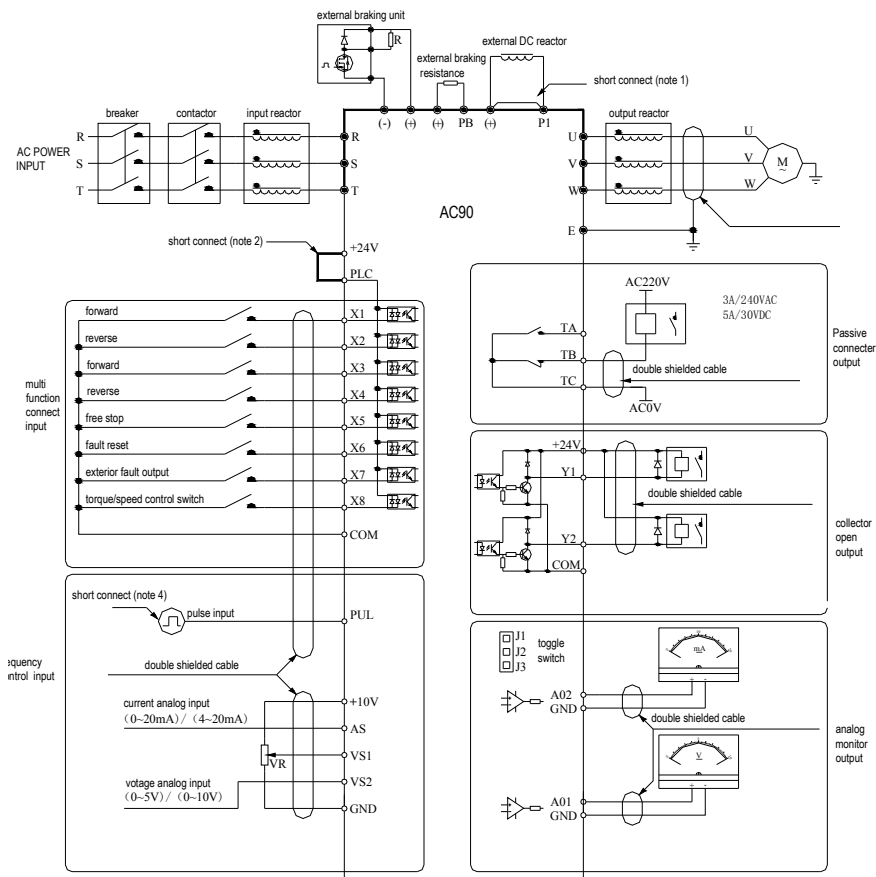

Chart 3-18: AC90 series inverter standard diagram

- Note:
1. While install DC reactor, be sure to dismantle the short connector between terminal P1 and (+) .
 2. NPN or PNP transistor signal can be selected as input of multi-function input terminal (X1~X8) . Inverter built-in power supply (+24V terminal) or external power supply (PLC terminal) can be chosen as bias voltage. Factory setting '+24V' short connect with 'PLC' .
 3. Analog monitor output is special output of meters such as frequency meter, current meter, voltage meter and etc. It can not be used for control operations such as feedback control.
 4. As there are multi pulse styles, please refer to the line connect mode description details.

● Auxiliary terminal output capacity

Terminal	Function definition	Max output
+10V	10V auxiliary power supply output,constitutes loop with GND.	50mA
A01/A02	Analog monitor output, constitutes loop with GND.	As frequency,voltage signal, max output 2mA
+24V	24V auxiliary power supply output,constitutes loop with COM.	100mA
Y1/Y2	Collector open circuit output can set the action-object by programme.	DC24V/50mA
TA/TB/TC	Passive connector output can set the action-object by programme.	3A/240VAC 5A/30VDC

Chart 3-4: AC90 series inverter auxiliary terminals output capacity

● Switch terminals connection function specification





Switch terminal	Selectable position	Picture example	Function specification
	J1		0.2--50kHz frequency output
	J2		0--20mA current output 4--20mA current output
	J3		0--10V voltage output
	J4 J6		Out track selection J4 J6 (with PG card) Inner track selection J5 J7 (without PG card)
	J5 J7		

Chart 3-5: AC90 series inverter switch terminal connection function specification

Main circuit terminals

● Main circuit terminals array and definition

Power under 18.5kW main circuit terminals array:

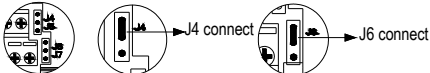
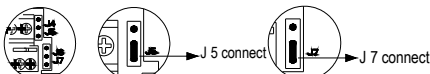

Power under 22~110kW main circuit terminals array:

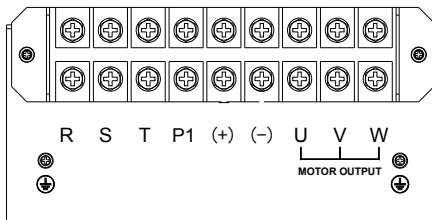

Power under 132~560kW main circuit terminals array:

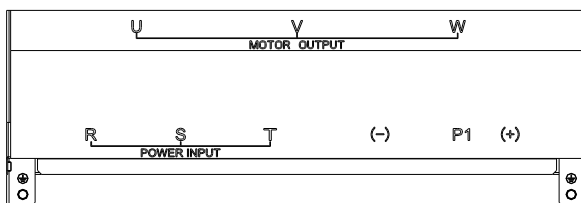

Terminal	Name	Function definition
(-)	DC power terminal	DC power output, (-) means DC bus cathode, (+) means DC bus anode, used for external braking unit.
(+)		
(+)	Braking resistance terminal	Used for external braking resistance to realize quick stop.
PB		
P1	DC reactor terminal	Used for external DC reactor.
(+)		
R	Inverter input terminal	Used to connect 3-phase AC power supply.
S		
T		
U	Inverter output terminal	Used to connect the motor.
V		
W		
⊕	Earth	Earth terminal, earth resistance<10 OHM
E		

Chart 3-6:AC90 series inverter main circuit terminals array and definition

● 3-phase 380V machine main circuit wiring

Model	Main circuit terminals screw specifications	Suggested fixed moment (N·m)	Suggested Copper-core cable specification mm ²
AC90-T3-R75T	M4	1.2--1.5	1.5mm ² (14)
AC90-T3-1R5T	M4	1.2--1.5	2.5mm ² (12)
AC90-T3-2R2T	M4	1.2--1.5	2.5mm ² (12)
AC90-T3-004T	M4	1.2--1.5	4mm ² (10)
AC90-T3-5R5T	M4	1.2--1.5	6mm ² (9)
AC90-T3-7R5T	M5	2--2.5	6mm ² (9)
AC90-T3-011T	M5	2--2.5	10mm ² (7)
AC90-T3-015T	M6	4--6	10mm ² (7)
AC90-T3-018T	M6	4--6	16mm ² (5)
AC90-T3-022T	M8	8--10	16mm ² (5)
AC90-T3-030T	M8	8--10	25mm ² (3)
AC90-T3-037T	M8	8--10	25mm ² (3)
AC90-T3-045T	M8	8--10	35mm ² (2)
AC90-T3-055T	M10	11--13	35mm ² (2)
AC90-T3-075T	M10	11--13	50mm ² (1)
AC90-T3-090T	M10	11--13	50mm ² (1/0)
AC90-T3-110T	M10	11--13	70mm ² (2/0)
AC90-T3-132T	M10	11--13	95mm ² (3/0)
AC90-T3-160T	M12	14--16	95mm ² (4/0)
AC90-T3-185T	M12	14--16	120mm ²
AC90-T3-200T	M14	17--20	150mm ²
AC90-T3-220T	M14	17--20	150mm ²
AC90-T3-250T	M16	20--23	185mm ²
AC90-T3-280T	M16	20--23	185mm ²
AC90-T3-315T	M16	20--23	240mm ²
AC90-T3-355T	M16	20--23	240mm ²
AC90-T3-400T	M16	20--23	300mm ²
AC90-T3-450T	M16	20--23	400mm ²
AC90-T3-500T	M16	20--23	400mm ²
AC90-T3-560T	M16	20--23	500mm ²

Note: Here we suggest to use copper joins as mains electric connectors of machine over 185KW. Pls refer the cut section area above.

Chart 3-7: Suggested cable diameter and fixed moment 3-phase 380V machine main circuit

- Single-phase 220V machine main circuit wiring

Model	Main circuit terminals screw specifications	Suggested fixed moment (N·m)	Suggested Copper-core cable specification mm ²
AC90-S2-R40T	M4	1.2~1.5	1.5mm ² (14)
AC90-S2-R75T	M4	1.2~1.5	2.5mm ² (12)
AC90-S2-1R5T	M4	1.2~1.5	2.5mm ² (12)
AC90-S2-2R2T	M4	1.2~1.5	4mm ² (10)

Chart 3-8: Suggested cable diameter and fixed moment single-phase 220V machine main circuit

- Suggested main circuit components specification

Model	Contactor specification	Breaker specification	DC reactor	Input filter	Output filter
AC90-T3-R75T	10A	10A	-----	NFI-005	NFO-010
AC90-T3-1R5T	10A	10A	-----	NFI-005	NFO-010
AC90-T3-2R2T	16A	15A	-----	NFI-010	NFO-010
AC90-T3-004T	16A	20A	-----	NFI-010	NFO-010
AC90-T3-5R5T	25A	20A	-----	NFI-020	NFO-020
AC90-T3-7R5T	25A	30A	-----	NFI-020	NFO-020
AC90-T3-011T	32A	40A	-----	NFI-036	NFO-036
AC90-T3-015T	40A	50A	-----	NFI-036	NFO-036
AC90-T3-018T	50A	60A	-----	NFI-050	NFO-050
AC90-T3-022T	50A	75A	DCL-50	NFI-050	NFO-050
AC90-T3-030T	63A	100A	DCL-80	NFI-080	NFO-080
AC90-T3-037T	80A	125A	DCL-100	NFI-100	NFO-100
AC90-T3-045T	100A	150A	DCL-110	NFI-100	NFO-100
AC90-T3-055T	125A	175A	DCL-125	NFI-150	NFO-150
AC90-T3-075T	160A	200A	DCL-150	NFI-150	NFO-150
AC90-T3-090T	220A	250A	DCL-200	NFI-200	NFO-300
AC90-T3-110T	220A	300A	DCL-200	NFI-200	NFO-300
AC90-T3-132T	250A	400A	DCL-300	NFI-300	NFO-300
AC90-T3-160T	300A	500A	DCL-300	NFI-300	NFO-300
AC90-T3-185T	400A	600A	DCL-400	NFI-400	NFO-400
AC90-T3-200T	400A	700A	DCL-400	NFI-400	NFO-400
AC90-T3-220T	630A	800A	DCL-500	NFI-600	NFO-600
AC90-T3-250T	630A	1000A	DCL-600	NFI-600	NFO-600
AC90-T3-280T	630A	1200A	DCL-600	NFI-600	NFO-600
AC90-T3-315T	630A	1200A	DCL-800	-----	-----
AC90-T3-355T	800A	1400A	DCL-800	-----	-----
AC90-T3-400T	1000A	1600A	DCL-1000	-----	-----

AC90-T3-450T	1000A	2000A	DCL-1000	-----	-----
AC90-T3-500T	1000A	2000A	DCL-1200	-----	-----
AC90-T3-560T	-----	2000A	DCL-1200	-----	-----

Note: For DC reactor, input filter, output filter and other components specification details and circuit mode, please refer chapter 7 "peripheral equipments and options".

Chart 3-9: Suggested mains fittings for 3-phase 380V machine

Control loop terminals

- Control loop terminals array

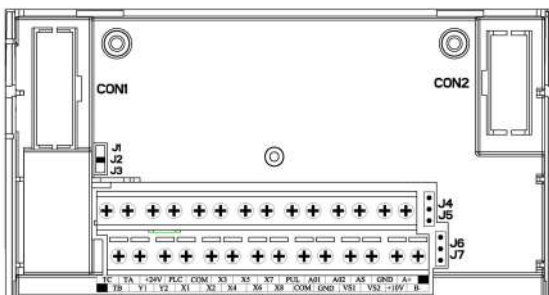

Sort	Terminal	Name	Function definition
Passive connection output	TA	Normally-open contact	Can set the action-object by programme. Max contact capacity:3A/240VAC 5A/30VDC
	TB	Normally-closed contact	
	TC	Common contact	
State output	Y1	Collector open output 1	Can set the action-object by programme. Max contact capacity:DC30V/50mA
	Y2	Collector open output 2	
Auxiliary power supply	+24V	Auxiliary power output +	Max output: 24VDC/100mA.
	COM	Auxiliary power output -	
Multi-function contact input	X1	Multi-function contact input 1 (forward)	Build-in photoelectric converter can set the action-object by programme. Input condition: Max DC30V/8mA. Note: Factory setting is common-collector characteristic input. If need common-emitter characteristic input, Please remove the short connector between "+24V" and "PLC", then use the short connector to connect "PLC" and "COM".
	X2	Multi-function contact input 2 (reverse)	
	X3	Multi-function contact input 3 (forward jog)	
	X4	Multi-function contact input 4 (reverse jog)	
	X5	Multi-function contact input 5 (free stop)	
	X6	Multi-function contact input 6 (fault reset)	

	X7	Multi-function contact input 7 (exterior fault input)	
	X8	Multi-function contact input8 (torque/speed control switch)	
	PLC	Multi-function contact input common terminal	
Pulse input	PUL	Pulse input	Pulse range:0.0~50.00kHz
Analog output	A01	Analog output 1	Can set the action and object by programme. Physical type of output signal: 0~10VDC.
	A02	Analog output 2	Can set the action-object by programme. Physical type of output signal:0~10V 0~20mA 4~0mA frequency pulse output, selectable by parameter [F3.26] or switch J1 J2 J3 (Details in chart 3-5)
Analog input	AS	Current analog input	As inverter control signal or feedback signal, can set the act range and response speed by programme? VS1/VS2 resistance:89KΩ; AS resistance: 250Ω.
	VS1	Voltage analog input 1	
	VS2	Voltage analog input 2	
Signal auxiliary power supply	+10V	Signal auxiliary power supply terminal	Max output 10VDC/50mA
	GND	Signal auxiliary power supply terminal	Common auxiliary power of analog output, analog input signal.
Communication terminal	A+	Communication terminal A+	RS485 communication port
	B-	Communication terminal B-	

Chart 3-10: AC90 series inverter control loop terminals array and definition

● Control loop terminal wiring specification

Terminal	Bolt specification (mm)	Fixed moment (N·m)	Cable specification (mm ²)	Cable type
A+ B-	M2.5	0.4~0.6	0.75	Twisted-pair shielded cable
+10V GND A01 A02 VS1 VS2 AS	M2.5	0.4~0.6	0.75	Twisted-pair shielded cable
+24V COM Y1 Y2 TA TB TC PLC PUL X1 X2 X3 X4 X5 X6 X7 X8	M2.5	0.4~0.6	0.75	Shielded cable

Chart 3-11: Control loop terminal wiring specification

Braking unit (braking resistance) connection

- Braking resistance connection of machine below 18.5KW

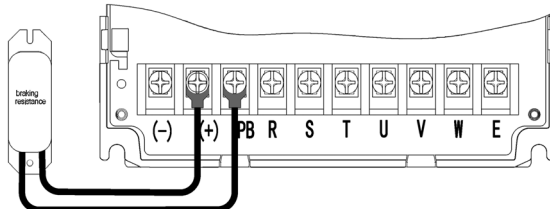

Chart 3-19: Braking resistance connection of AC90 series inverter below 18.5KW

- Braking unit connection of machine above 22KW

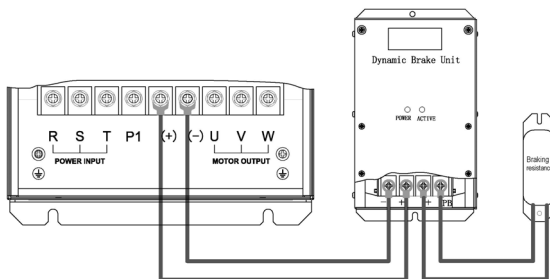

Chart 3-20: Braking resistance connection of AC90 series inverter above 22KW

- Suggested braking resistance specification parameters

Braking resistance value and power in the chart are decided according to common inertia load and intermittent braking mode. While used in large inertia occasion or long time frequent brake occasion, please adjust resistance value and power according to the inverter specification and the rated parameter of braking unit. If any problem, please consult customer service department of Shenzhen Veichi electric company.

Three-phase 380V			
Motor power(kW)	Resistance value(Ω)	Resistance power(kW)	Braking moment (%)
0.75 kW	750 Ω	150W	100%
1.5 kW	400 Ω	300W	100%
2.2 kW	250 Ω	400W	100%
4.0 kW	150 Ω	500W	100%
5.5 Kw	100 Ω	600W	100%
7.5 kW	75 Ω	780W	100%
11 kW	50 Ω	1,200W	100%
15 kW	40 Ω	1,500W	100%
18.5 kW	32 Ω	2,000W	100%
22 kW	28 Ω	2,200W	100%
30 kW	24 Ω	3,000W	100%

37 kW	20Ω	3,700W	100%
45 kW	16Ω	4,500W	100%
55 kW	13Ω	5,500W	100%
75 kW	9Ω	7,500W	100%
90 kW	6.8Ω	9,300W	100%
110 kW	6.2Ω	11,000W	100%
132 kW	4.7Ω	13,000W	100%
160 kW	3.9Ω	15,000W	100%
185 kW	3.3Ω	17,000W	100%
200 kW	3Ω	18,500W	100%
220 kW	2.7Ω	20,000W	100%
250 kW	2.4Ω	22,500W	100%
280 kW	2Ω	25,500W	100%
315 kW	1.8Ω	30,000W	100%
355 kW	1.5Ω	33,000W	100%
400 kW	1.2Ω	42,000W	100%
450 kW	1.2Ω	42,000W	100%
500 kW	1Ω	42,000W	100%
560 kW	1Ω	50,000W	100%
Single-phase 220V			
Motor power(kW)	Resistance value(Ω)	Resistance power(kW)	Braking moment (%)
0.4 kW	400Ω	100W	100%
0.75 kW	200Ω	120W	100%
1.5 kW	100Ω	300W	100%
2.2 kW	75Ω	300W	100%

Chart 3-12: Suggested braking resistance specification parameters of AC90 series inverter

- Build-in braking unit max braking performance

Braking unit of AC90 series product with low power can be selected according to the suggested braking resistance specification parameters in chart 3-11. In large inertia or long time frequent brake occasion, the moment maybe should be increased. The max braking power is showed in the following chart, the range of which can not be over in use. Otherwise the equipment maybe destroyed. If any problem, please consult Shenzhen Veichi electric company customer service department.

Three-phase380V			
Inverter model	Motor power	Max braking current	Min resistance
AC90-T3-R75T	0.75 kW	3.5A	200Ω
AC90-T3-1R5T	1.5 kW	3.5A	200Ω
AC90-T3-2R2T	2.2 kW	7A	100Ω
AC90-T3-004T	4 kW	10A	75Ω
AC90-T3-5R5T	5.5 Kw	10A	75Ω
AC90-T3-7R5T	7.5 kW	14A	50Ω
AC90-T3-011T	11 kW	17A	40Ω
AC90-T3-015T	15 kW	23A	30Ω
AC90-T3-018T	18.5 kW	28A	25Ω
Single-phase 220V			
Inverter model	Motor power	Max braking current	Min resistance
AC90-S2-R40T	0.4 kW	3.8A	100Ω
AC90-S2-R75T	0.75 kW	3.8A	100Ω
AC90-S2-1R5T	1.5 kW	6.5A	60Ω
AC90-S2-2R2T	2.2 kW	10.5A	40Ω

Chart 3-13:AC90 series inverter build-in braking unit max braking power

Multi-function contact input connection

- NPN transistor connection mode

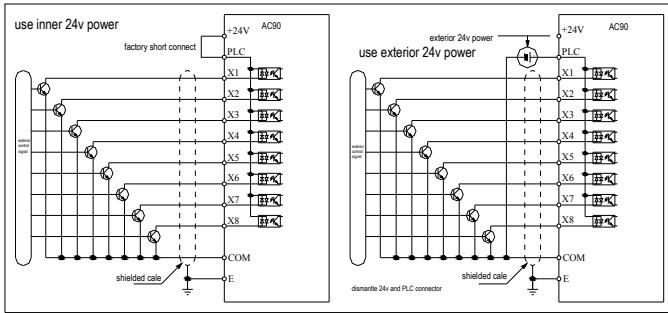

Chart 3-21: NPN transistor digital input signal connection mode

- NPN transistor connection mode

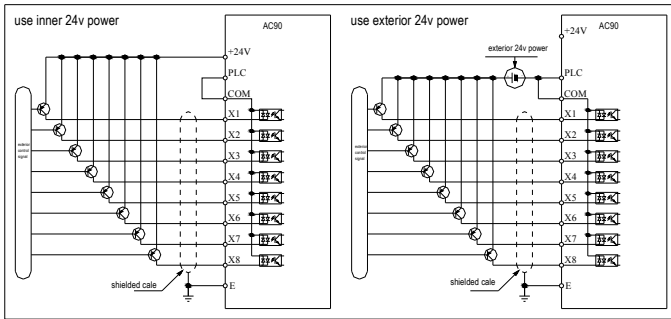
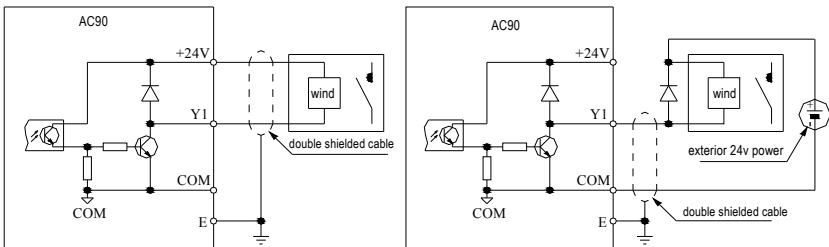

Chart 3-22: NPN transistor digital input signal connection mode

Digital output signal connection



control exterior relay by inner 24V power of inverter

control exterior relay by inner 24V power of inverter

Chart 3-23: AC90 series inverter digital output signal connection mode

Analog output signal connection

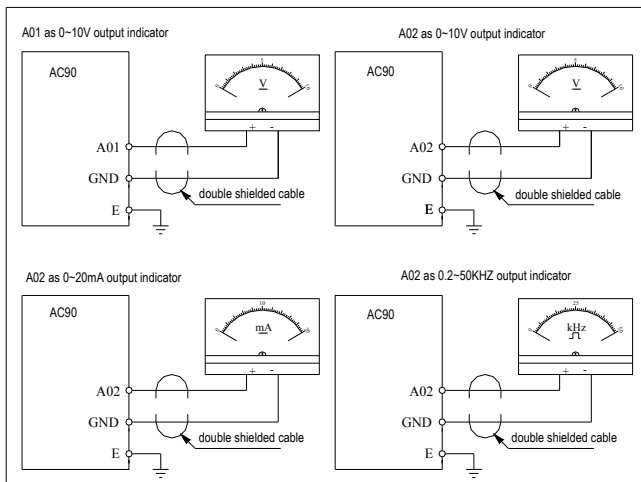

Chart 3-24: AC90 series inverter analog output signal connection mode

Connection of pulse input signal

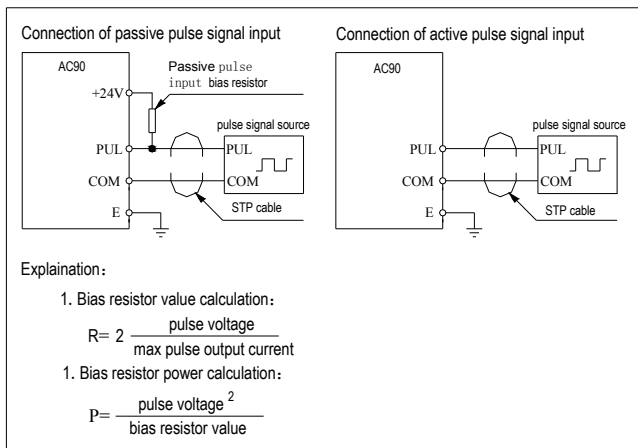

Chart 3-25: Pulse input signal connection mode of AC90 series inverter

Standby control system

Frequency inverter is composed of semiconductor, passive electronic component and driving part. All of them have useful time, what means these parts may happen characteristic change or out of use while in normal working environment. And it will cause product fault. To avoid production stopping led by the fault, we suggest to prepare standby control system while use the inverter.

Chart3-23 is a standby control system for manual switch to power supply driving motor at inverter fault. Standby control systems such as power supply Y/Δ step-down start way driving motor, power supply self-coupling reduction voltage start mode driving motor, power supply soft start mode driving motor or standby inverter system can be chose to use according the actual requirement and environment.

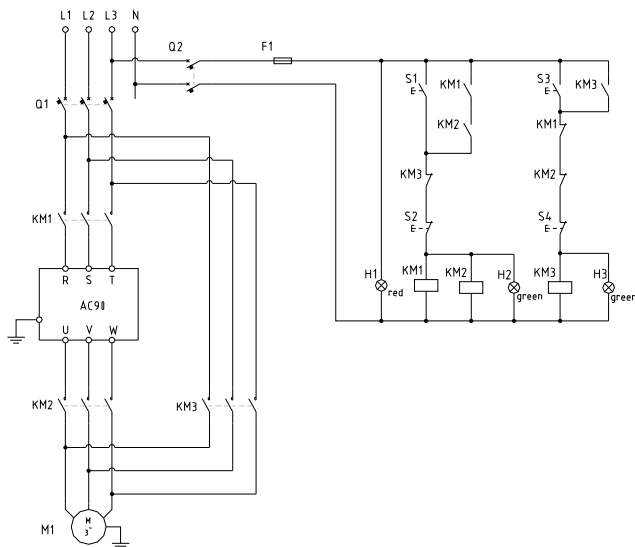





Chart 3-26: Standby control system of power supply directly driving mode

Chapter 4 Basic Operation and Trial Run

4.1 Safety Precautions









	<ul style="list-style-type: none"> ● No wiring while power supply is connected. Otherwise there is danger of electric shock.
	<ul style="list-style-type: none"> ● No operation while the cover is open. Otherwise, there is danger of electric shock. ● Please ensure reliable earth. Otherwise, there is danger of electric shock and fire. ● Before wiring please cut power supply of all related equipments and ensure main DC voltage in safe range. And please do operation after 5 mins. ● Only professional trained person is allowed to operate this product. ● Please do not dismantle the inverter cover while it is electrified. Otherwise, there is danger of electric shock. ● Please do not touch the printed circuit board of the inverter while it is electrified. Otherwise, there is danger of electric shock. ● Please ensure reliable mains cable connection. If the mains cable is loose, there is danger of fire caused by joint overheat. ● Before electrifying, please check the power voltage again. Wrong power voltage can cause fault or damage the inverter, even cause fire. ● Please do not install inverter on flammable material or attach flammable material to the inverter. Before electrifying, please clear the surroundings.
	<ul style="list-style-type: none"> ● While operation, please follow the ESD regulations. Otherwise, the inverter may be damaged. ● Please don't cut the power directly while the inverter drives the motor running. The power can't be cut until the motor totally stop. Otherwise, the inverter may be damaged. ● Please don't cut or connect motor while the inverter drives the motor running. The motor can't be cut or connect until the inverter output is 0. Otherwise, the inverter may be damaged. ● Control cable should be twisted-pair shielded cable. The barrier should be connected to the inverter earth terminal reliably to prevent the inverter from abnormal working. ● Unprofessional person can not operate, install, wiring, debug and maintain. ● Change, dismantle or maintain without permission may cause inverter damage. This case is not in our quality assurance range.

4.2 Keyboard layout and functions specification

● Keyboard appearance



● Key function

Key	Name	Function
	Menu key	Enter menu while standby or running. Press this key to return while modify parameter. While standby or running, press for 1 sec to enter condition monitoring interface.
	Confirm/modify key	Press to modify parameter while in menu interface. Press again to confirm after modifying. While standby or running, press to change LED monitoring items at stop.
	Up/down key	Select parameter group in menu interface. Modify parameter while in modify interface. Modify given frequency, PID, given torque or magnetic powder clutch given torque while at standby or condition monitoring state (While given frequency, PID, given torque or magnetic powder clutch given torque are set by keyboard and [F4.04])
	Shift key	Select digit of function no modified by up/down key; Select parameter digits modified by up/down key. Change LED monitoring items while standby or running.
	Forward run key	While run/stop is controlled by keyboard, press this key, the inverter forward rotate and the indicator is always on. While reverse, the indicator sparks.
	Jog/reverse key	This key function can be defined by parameter [F4.02]. Press it, machine reverses and indicator is off if this key is defined as REVERSE. Machine will jog and indicator is on if this key is defined as JOG.
	Stop/reset key	Machine stops if press it while run/stop is controlled by keyboard. Its efficiency range is defined via function no [F4.03]. Inverter resets if press it in fault state (no reset if fault is not solved).
	Keyboard potentiometer	Can be used as input channel for given frequency, upper frequency limit, given torque, given PID or PID feedback setting.

● Indicator light meanings

Name	State	Meaning	
Unit indicator light	Hz	Spark	Digital display given requery.
	Hz	On	Digital display output frequency.
	A	On	Digital display actual output current.
	V	On	Digital display input voltage.
	V	Spark	Digital display output voltage.
	S	On	Time unit is second.
	S	Spark	Time unit is ms, min, or h.
	RPM	On	Digital display motor speed.
	%	Spark	Digital display given PID.
	%	On	Digital display PID feedback.
State indicator light	FWD	On	Inverter is forward rotating.
	FWD	Spark	Inverter is reverse rotating.
	FWD	Off	Inverter stops.
Function indicator light	REV/JOG	On	Jog.
	REV/JOG	Off	Reverse.

Chart 4-1: Indicator light meanings

● Number and character table

Number, character	LED display	Number, character	LED display	Number, character	LED display
0	0	C	C	O	0
1	1	D	1	P	1
2	2	E	2	Q	2
3	3	F	3	R	3
4	4	G	4	S	4
5	5	H	5	T	5
6	6	I	6	U	6
7	7	J	7	V	7
8	8	K	8	W	88
9	9	L	9	X	No display
A	A	M	00	Y	4
B	6	N	1	Z	No display

Chart 4-2: Number and character table

● **Basic LED operation**

It displays frequency 50.00Hz when stop. Here F0.09=100.00 setting will be taken as an example to explain the basic LED operation.

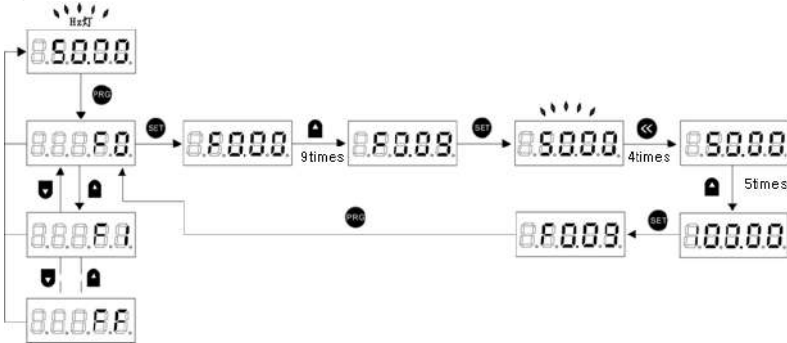

Chart 4-1: Basic LED operation

4.3 Basic operation

● **Parameter initialization**

After setting F0.19=1, parameter initialization is finished. Operation details as follows:

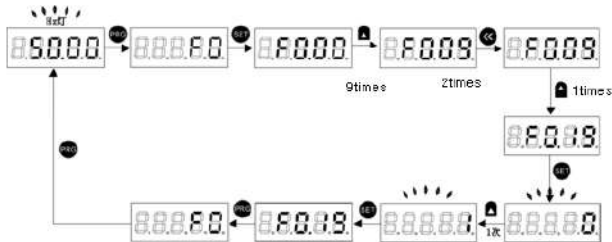

Chart 4-2: Parameter initialization

● **Core control mode selections**

Four core control mode selections:

- 0: VC without PG
- 1: V/F without PG
- 2: VC with PG
- 3: V/F with PG

Here we set F0.00=0 (VC without PG control) as an example to introduce it

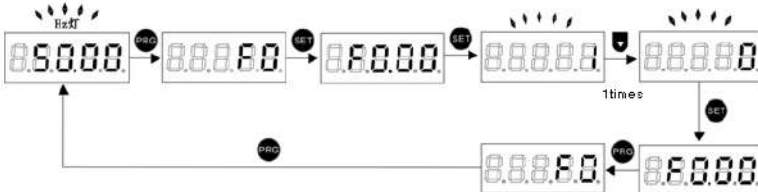

Chart 4-3: Core control mode selections

● Acceleration/deceleration time selections

There are 4 groups of acc/dec time. If no note, it is acc/dec time 1. Take setting F0.14=8.0 (acc/dec time 1) as example:

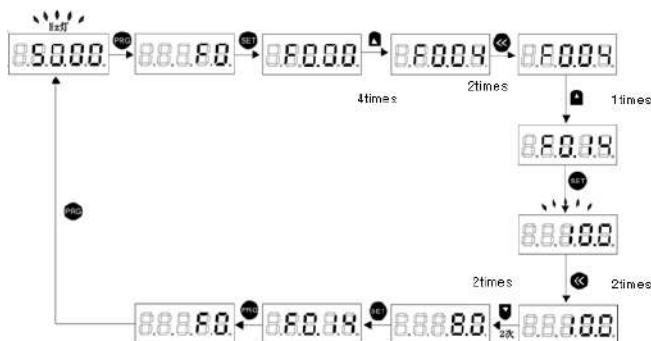

Chart 4-8: Acceleration/deceleration time selections

● Motor parameter setting

Set [F5.02] (motor rated power), [F5.03] (motor rated frequency), [F5.04] (motor rated speed), [F5.05] (motor rated voltage) according to the motor nameplate. Other parameter setting can be got by inverter self-study.

Please refer to the following operation mode chart:

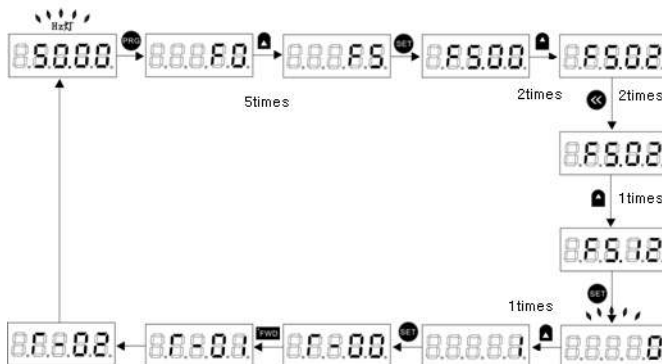

Chart 4-9: Motor parameter setting

● Parameter copy function selection

Set F4.05=1, send inverter parameter to keyboard and save:

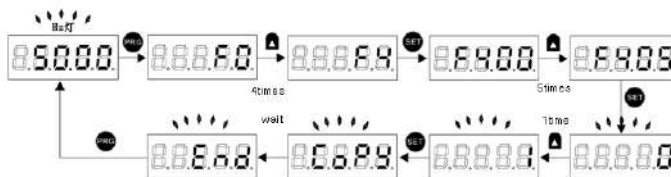

Chart 4-10: Send inverter parameter to keyboard and save

4. 4 Trial run

● Trial run debugging guide

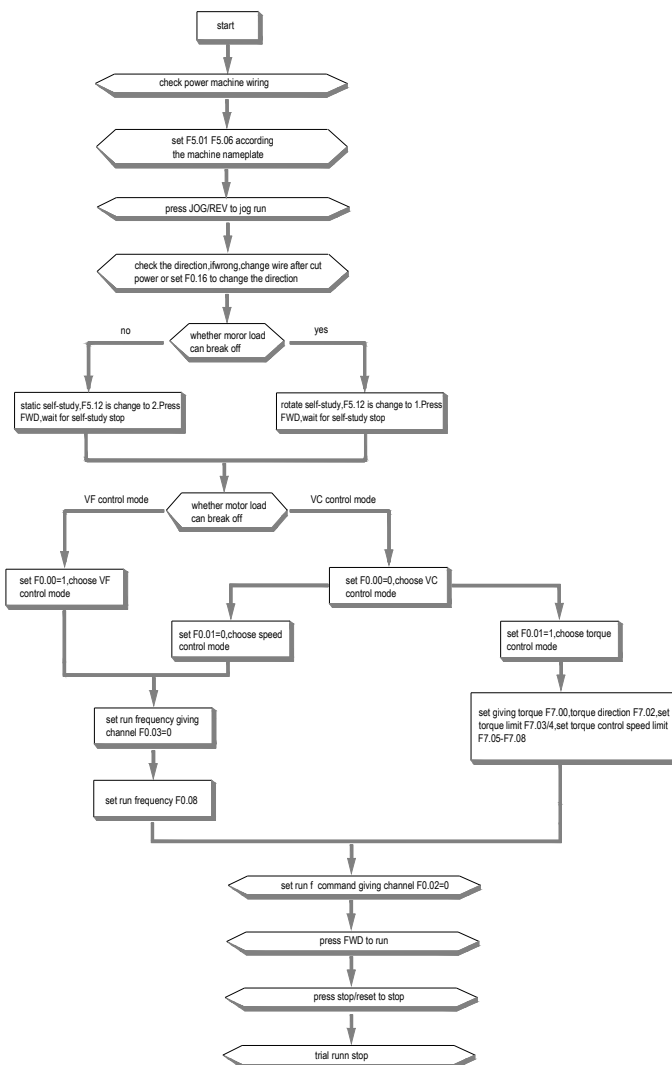

Chart 4-13: Trial run

● Parameter self-tuning selection

Motor parameter self-tuning

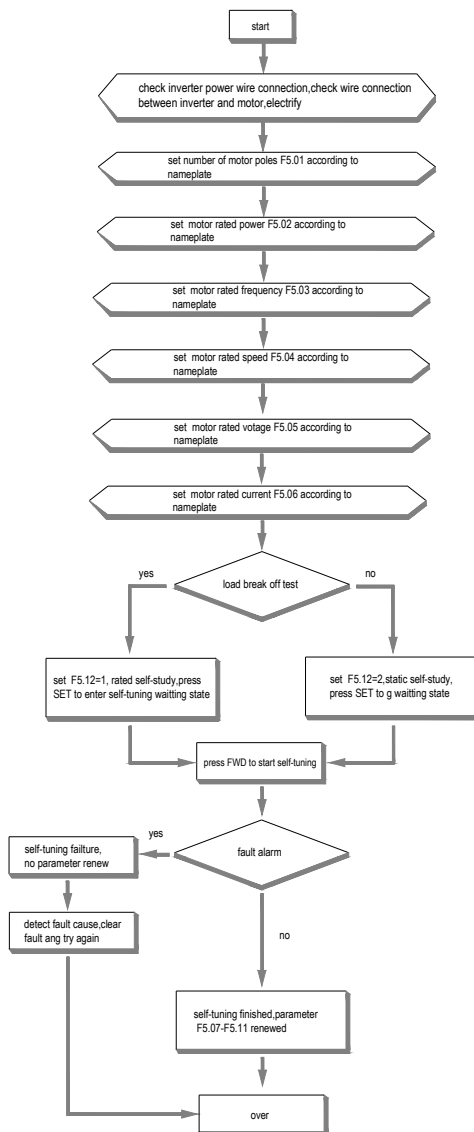

Chart 4-14: Parameter self-tuning selections

● Frequency giving flow

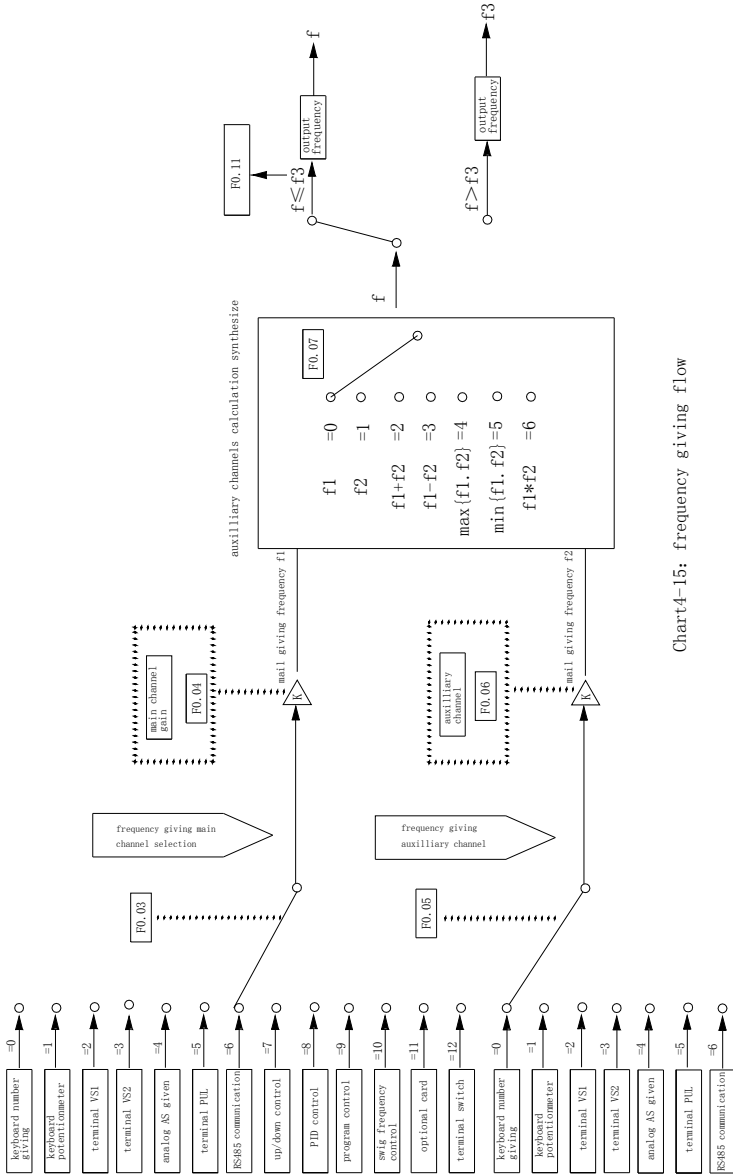

Chart4-15: frequency giving flow

● Torque giving flow

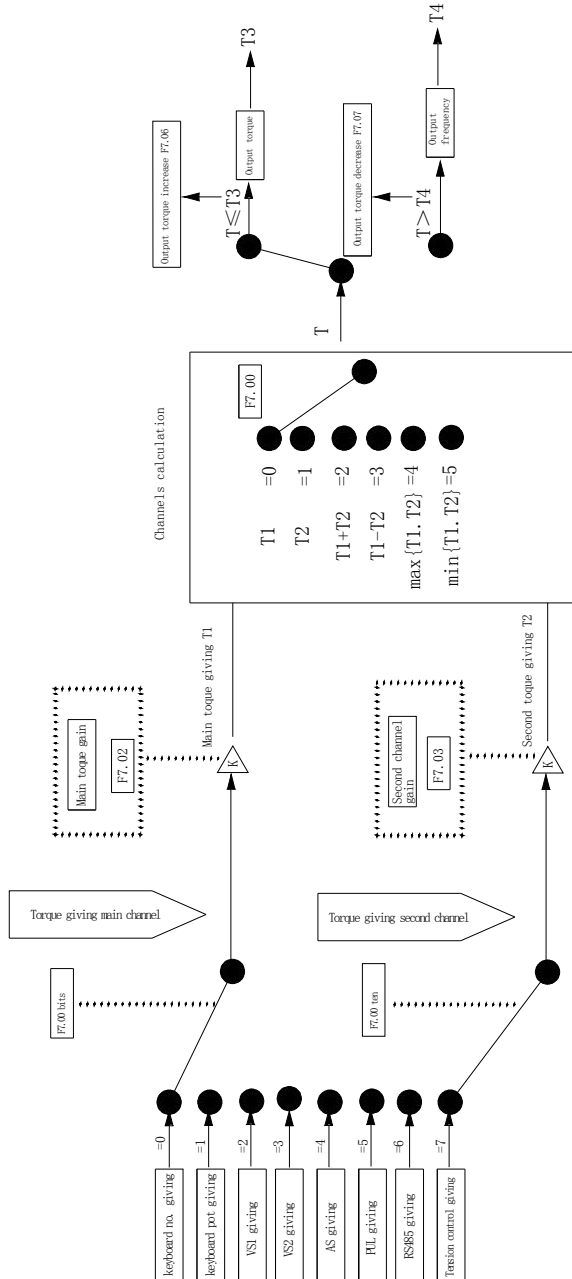

Chart4-16: Torque giving flow

● Start/stop control flow

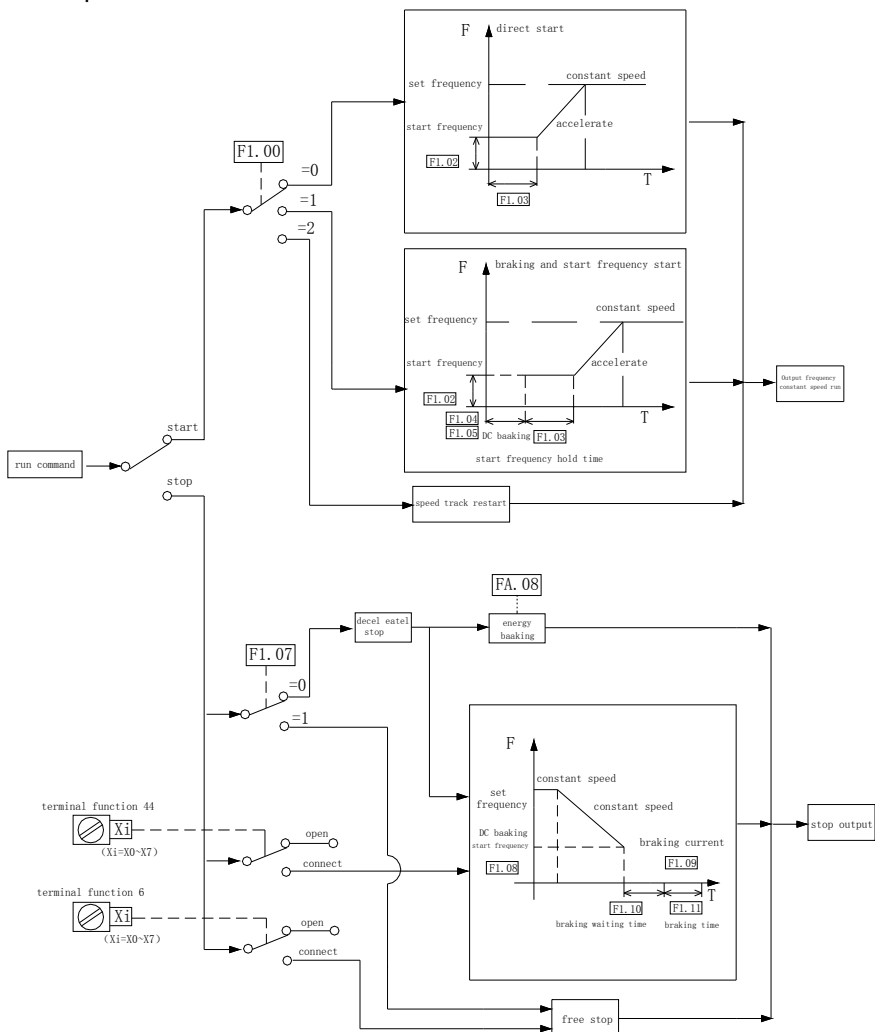
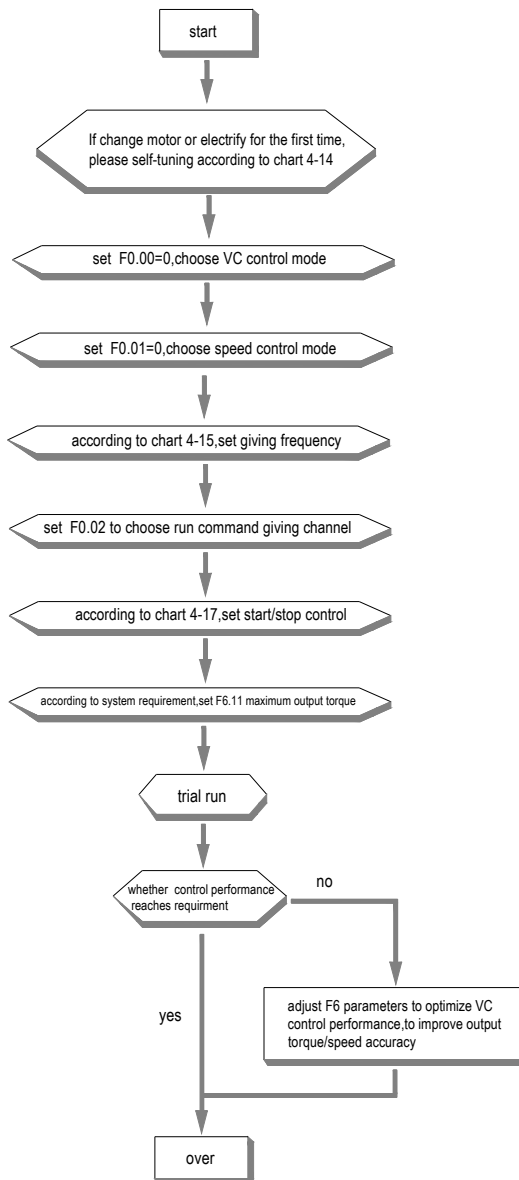

Chart 4-17: Start/stop control flow

● Open-loop VC control (speed mode)**Chart 4-18: Open-loop VC control**

● Open-loop VC control (torque mode)

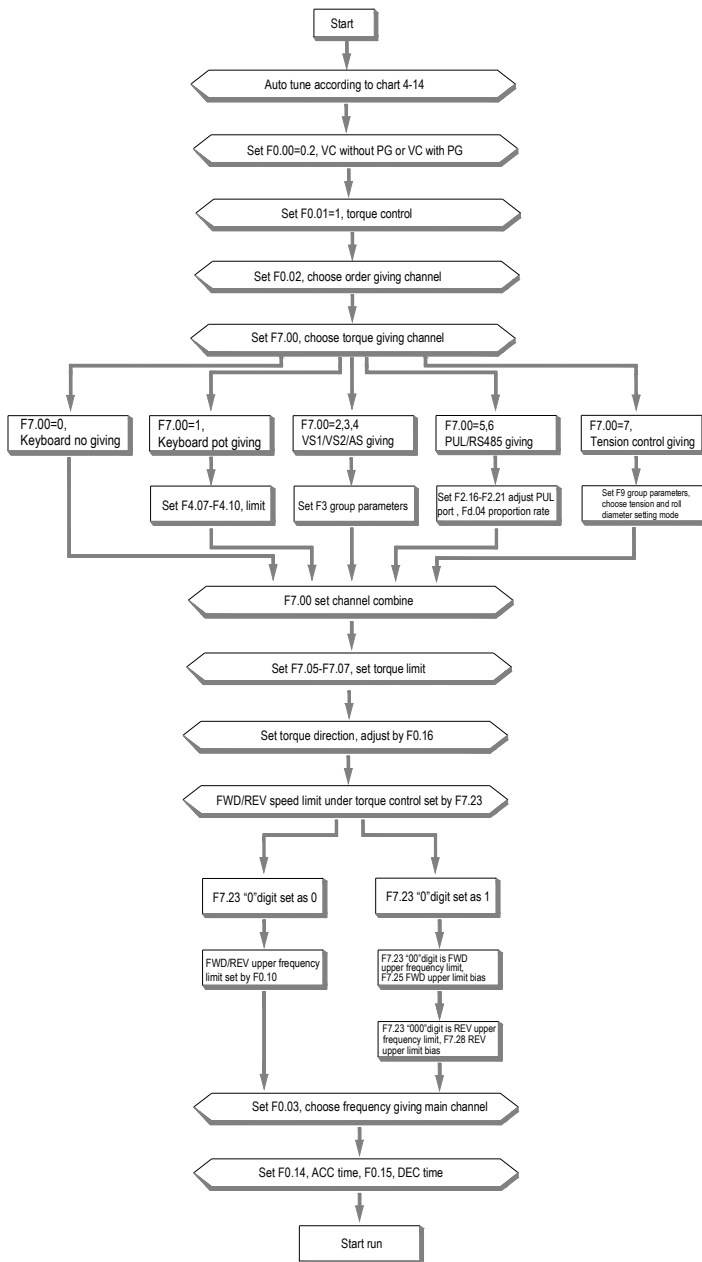

Chart 4-19: Torque control

● Open-loop /closed loop VC control (Tension setting of torque mode tension control)

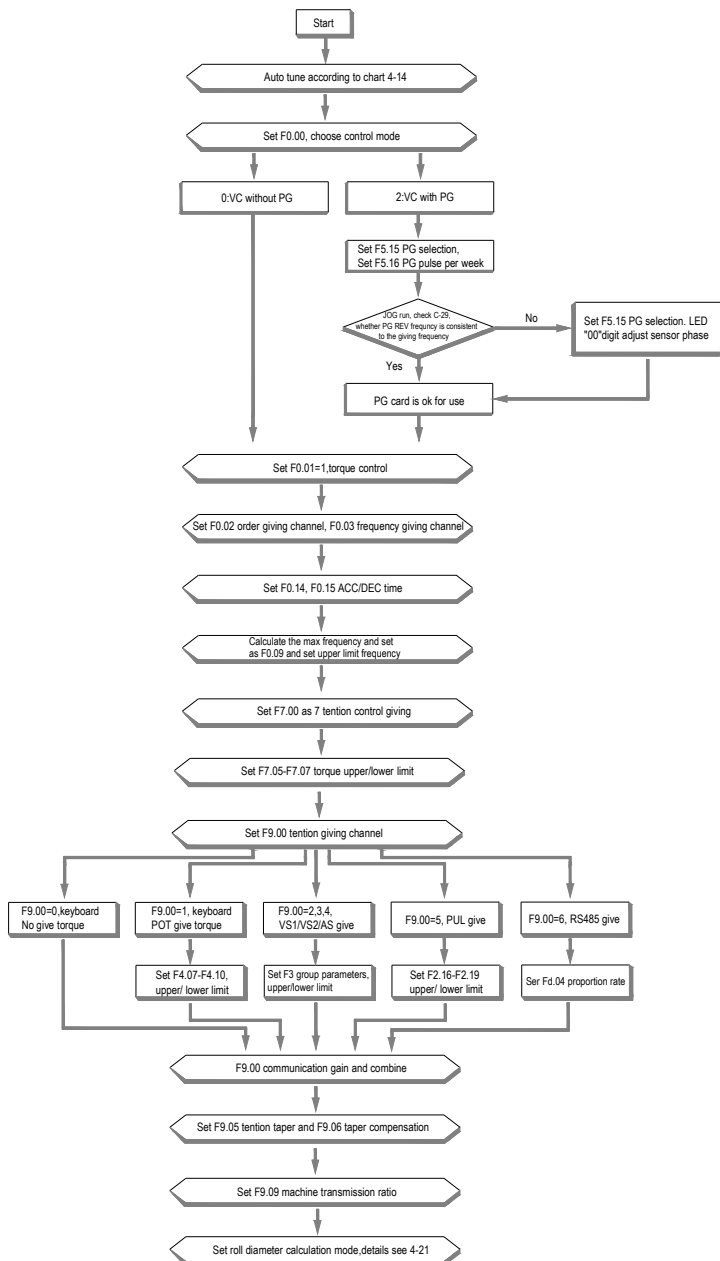

Chart 4-20: Tention setting under torque control mode

● Open-loop /closed loop VC control (Roll diameter setting of torque mode tension control)

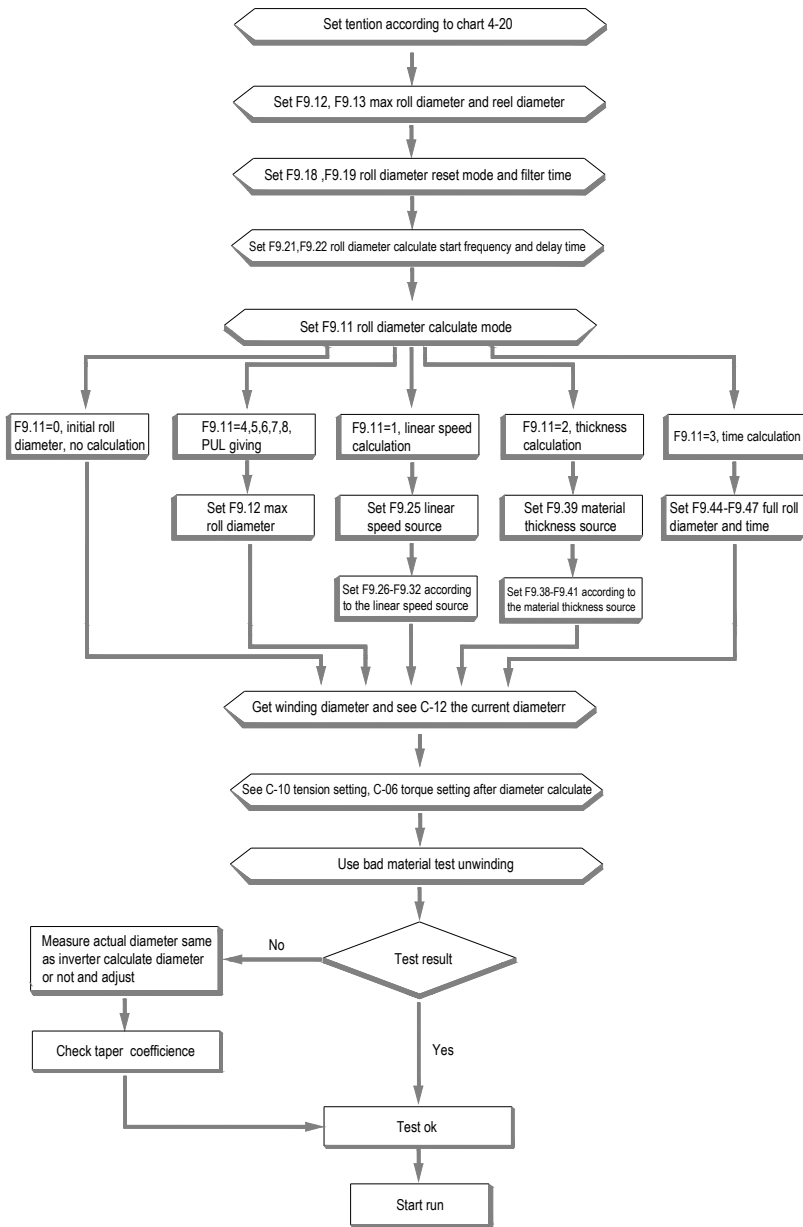

Chart 4-21: Roll diameter setting of torque mode tension control





Chapter 5 Fault Diagnoses and Processing

This chapter explains the display content and process of the inverter fault, alarm and operation fault. It also simply explains the bad situation caused by inverter or motor fault and how to solve it. For the adjustment guide in trial run, please refer to this chapter too.



5.1 Fault types













Type	Inverter action while fault happens
Equipment fault	<p>While inverter detect fault, the state likes this:</p> <ul style="list-style-type: none"> ● Keyboard display character showing fault content. ● Inverter stops output. Motor free slide stops. ● While function F2.22/F2.23 is set as 3(output fault), Y1/Y2 terminals output valid open-collector digital output. ● While function F2.24 is 3(fault output), TA-TC terminals output open passive digital output. ● While there is fault as OL, OC, SC, OV, UL2, if FA.15 is not 0, the inverter will restart automatically after FA.16 setting time.
External fault	<p>In certain application occasions, external related equipments fault signals are considered in the inverter control system as usage of monitoring, protection or switch control. At this time, if one multi function terminal is defied as "external fault", the inverter stops output alarm signal.</p>

5.2 Fault information and details

Keyboard display	Fault code	Fault type	Possible causes	Treatment
	L.U.1	Too low while stop	<ul style="list-style-type: none"> ● Power supply is too low ● Voltage detection circuit is abnormal 	<ul style="list-style-type: none"> ● Check input power, eliminate fault. ● Seek support from factory.
	E.LU2	Too low voltage in run	<ul style="list-style-type: none"> ● Power supply is too low ● Power capacitance is too small, or there is big impact current in the power grid. ● Inner DC main contactor is not closed. 	<ul style="list-style-type: none"> ● Check input input power, eliminate fault. ● Improve power-supply system. ● Seek support from factory.
	E.oU1	Acc over-voltage	<ul style="list-style-type: none"> ● Power voltage fluctuation over limit. ● Start running motor . 	<ul style="list-style-type: none"> ● Detect power voltage and eliminate fault. ● Restart motor until it totally stop.Set F1.00 as 1or 2.
	E.oU2	Dec over-voltage	<ul style="list-style-type: none"> ● Deceleration time is too short. ● Load potential energy or inertia is too large. ● Power voltage fluctuation over limit. 	<ul style="list-style-type: none"> ● Prolong deceleration time properly. ● Reduce load inertia or improve inverter capacitance or add braking unit. ● Detect input power and clear fault.

E.oU3	E.oU3	Constant speedover-voltage	<ul style="list-style-type: none"> ● Power voltage fluctuation over limit. 	<ul style="list-style-type: none"> ● Detect input power voltage and eliminate fault. ● Install input reactor.
E.oU4	E.oU4	Over-voltage while stop	<ul style="list-style-type: none"> ● Power voltage fluctuation over limit. 	<ul style="list-style-type: none"> ● Check input power, eliminate fault. ● Seek support from factory.
E.oC1	E.oC1	Acc over-current	<ul style="list-style-type: none"> ● Acceleration time is too short. ● Start running motor. ● V/F curve setting is not suitable.Or torque boost too high. ● Inverter capacitance is too small. 	<ul style="list-style-type: none"> ● Prolong acc time. ● Restart motor until it totally stop.Set F1.00 as 1or 2. ● Reset V/F curve or torque boost value. ● Select inverter with right capacitance.
E.oC2	E.oC2	Dec over-current	<ul style="list-style-type: none"> ● Deceleration time is too short. ● Load potential energy or inertia is too large. ● Power voltage fluctuation over limit. 	<ul style="list-style-type: none"> ● Prolong deceleration time. ● Connect external braking resistance or braking unit. ● Select inverter with right capacitance.
E.oC3	E.oC3	Constant speedover-current	<ul style="list-style-type: none"> ● Sudden load change. ● Power grid voltage is too low. 	<ul style="list-style-type: none"> ● Check load change and eliminate it. ● Check input power, eliminate fault.
E.oL1	E.oL1	Motor over-load	<ul style="list-style-type: none"> ● V/F curve setting is not suitable.Or torque boost too high. ● Power grid voltage is too low. ● Unright overload protection setting. ● Locked-rotor run or too heavy load. ● Universal motor long time low speed run. 	<ul style="list-style-type: none"> ● Reset V/F curve or torque boost value. ● Check input power, eliminate fault. ● Unreasonable F5.06 setting. ● Adjust load or select inverter with right capacitance. ● If need long low-speed operation, please choose special motor for inverter.
E.oL2	E.oL2	Inverter over-load	<ul style="list-style-type: none"> ● Load is too heavy. ● Acceleration time is too short. ● Start running motor. ● V/F curve setting is not suitable.Or torque boost too high. 	<ul style="list-style-type: none"> ● Select inverter with right capacitance. ● Prolong acceleration time ● Restart motor until it totally stop. Set F1.00 as 1or2. ● Reset V/F curve or torque boost value.
E. SC	E. SC	System abnormality	<ul style="list-style-type: none"> ● Acceleration time is too short. ● Short circuit between 	<ul style="list-style-type: none"> ● Prolong acceleration time properly. ● Check periphery equipments

			<p>inverter output phases or earth.</p> <ul style="list-style-type: none"> ● Module is damaged. ● Electromagnetic disturb. 	<p>and restart after fault eliminating.</p> <ul style="list-style-type: none"> ● Seek support from factory. ● Check system wiring, earth, shield and deal as required.
	E.oH1	Inverter over-heat	<ul style="list-style-type: none"> ● Temperature is too high. ● Air channel is blocked. ● Fan connection parts is loose. ● Fan is damaged. ● Temperature detection circuit fault 	<ul style="list-style-type: none"> ● Make the environment meet the requirement. ● Clear the air channel. ● Check and reconnect the wire ● Change the same new fan. ● Seek support from factory.
	E.oH2	Rectifier over-heat	<ul style="list-style-type: none"> ● Temperature is too high. ● Air channel is blocked. ● Fan connection parts is loose. ● Fan is damaged. ● Temperature detection circuit fault 	<ul style="list-style-type: none"> ● Make the environment meeting the requirement. ● Clear the air channel. ● Check and reconnect the wire. ● Change the same new fan. ● Seek support from factory.
	E.Fb1	PID feedback over upper limit	<ul style="list-style-type: none"> ● PID feedback breaks. ● PID feedback channels parameter is set wrongly. ● Analog feedback channel is abnormal. 	<ul style="list-style-type: none"> ● Check PID feedback wire. ● Check the PID feedback channel parameter setting. ● Seek support from factory.
	E.Fb2	PID feedback over lower limit	<ul style="list-style-type: none"> ● PID feedback breaks. ● PID feedback channels parameter is set wrongly. ● Analog feedback channel is abnormal. 	<ul style="list-style-type: none"> ● Check PID feedback signal wire. ● Check the PID feedback channel parameter setting. ● Seek support from factory.
	E.TE1	Motor static detection fault	<ul style="list-style-type: none"> ● Detection overtime ● Start static detection while motor is running. ● Capacitance difference is too big between motor and inverter. ● Motor parameter setting mistake. 	<ul style="list-style-type: none"> ● Check motor connection wire. ● Detect after motor stopping totally. ● Change inverter model. ● Reset parameter according to nameplate.
	E.TE2	Motor rotation detection fault	<ul style="list-style-type: none"> ● Detect while motor is running. ● Detect with load. ● Detection overtime ● Capacitance difference is too big between motor and inverter. ● Motor parameter setting mistake. 	<ul style="list-style-type: none"> ● Detect after motor stop totally. ● Re-detect without load. ● Check motor connection wire. ● Change inverter model. ● Reset parameter according to nameplate.

	E.EEP	Memory fault	<ul style="list-style-type: none"> ● Electromagnetic disturb in memory period. ● EEPROM damage. 	<ul style="list-style-type: none"> ● resume load and save. ● Seek support from factory.
	LIFE	Reserved	<ul style="list-style-type: none"> ● 	<ul style="list-style-type: none"> ● Seek support from factory.
	E.ILF	Input side open phase	<ul style="list-style-type: none"> ● 3-phase input power open phase. 	<ul style="list-style-type: none"> ● Check 3-phase power supply and the phase. ● Check 3-phase power supply wiring.
	E.oLF	Ouput side open phase	<ul style="list-style-type: none"> ● 3-phase output power open phase 	<ul style="list-style-type: none"> ● Check 3-phase output voltage and current. ● Check wiring.
	E.Gnd	Output earth	<ul style="list-style-type: none"> ● Output earth terminal short circuit. 	<ul style="list-style-type: none"> ● Check wiring and insulation.
	E.HAL	Current detection fault	<ul style="list-style-type: none"> ● Detect circuit fault. ● Phase imbalance 	<ul style="list-style-type: none"> ● Seek for technic support. ● Check motor and wiring.
	E.EF	Inverter external fault	<ul style="list-style-type: none"> ● Peripheral equipment fault protection. 	<ul style="list-style-type: none"> ● Check peripheral equipment.
	E.PAn	Keyboard connect fault	<ul style="list-style-type: none"> ● Keyboard wire fault. ● Keyboard component damage. 	<ul style="list-style-type: none"> ● Check keyboard wire. ● Seek support from factory.
	E.CE	Rs485communication fault	<ul style="list-style-type: none"> ● Unsuitable baud rate setting. ● Communication wire breaks. ● Communication format does not match upper machine. 	<ul style="list-style-type: none"> ● Set suitable baud rate setting. ● Check communication wire. ● Set right communication format.
	E.CPE	Parameter copy fault	<ul style="list-style-type: none"> ● Parameter copy communication is fault. ● Copy keyboard is not match the inverter. 	<ul style="list-style-type: none"> ● Check wire. ● Select the specified external keyboard model.
	E.ECF	Extend card connection fault	<ul style="list-style-type: none"> ● Communication between extend card and frequency inverter overtime. ● Extend card does not match frequency inverter. 	<ul style="list-style-type: none"> ● Check connector, and re-insert wire. ● Choose the named card.
	E.PG	PG card connection abnormal	<ul style="list-style-type: none"> ● PG card and inverter connection failure 	<ul style="list-style-type: none"> ● Check the connection

<p style="color: red; font-weight: bold; font-size: 1.2em;">E.P. Id</p>	<p>E.PID</p>	<p>PID feedback failure</p>	<ul style="list-style-type: none"> ● PID feedback upper limit of disconnection alarm is improper ● PID feedback lower limit of disconnection alarm is improper ● PID feedback wiring unreliable ● Sensor with feedback failure ● Feedback input loop failure 	<ul style="list-style-type: none"> ● Confirm the sensor state, if broken, change it. ● Repair the wiring. ● Confirm the setting value of [Fb.16] and [Fb.17].
---	--------------	-----------------------------	---	--

Chart 5-1: Fault information and details

5.3 Fault diagnoses process

System fault diagnoses process

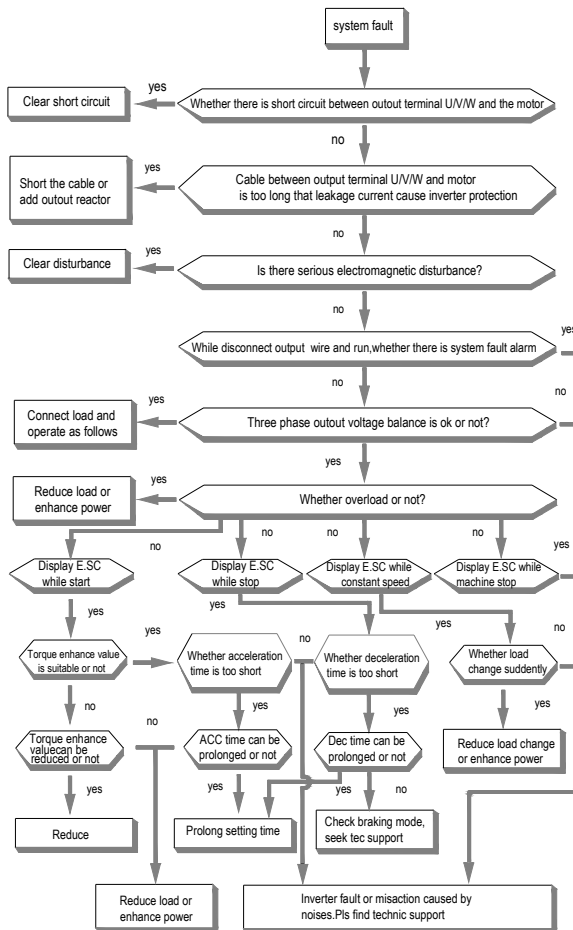

Over current diagnoses process

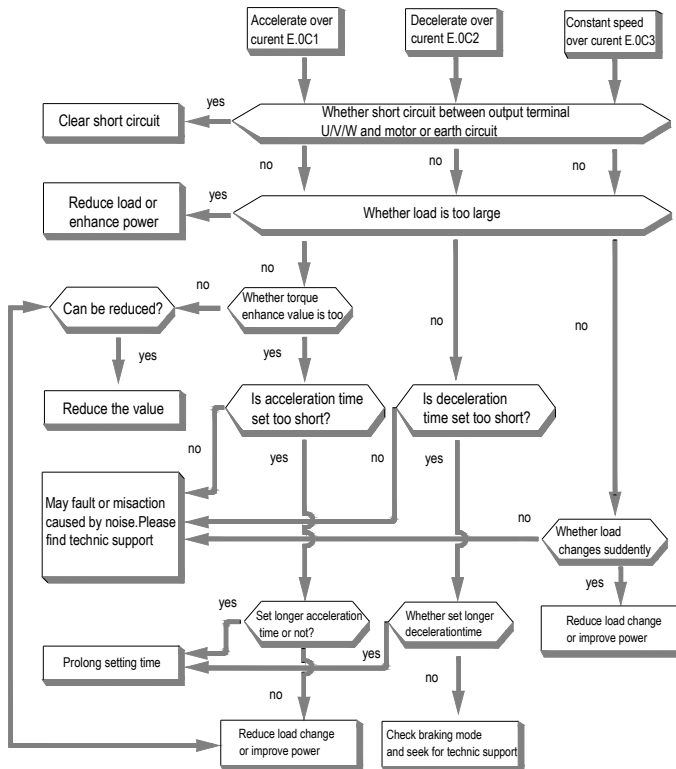

Over voltage diagnoses process

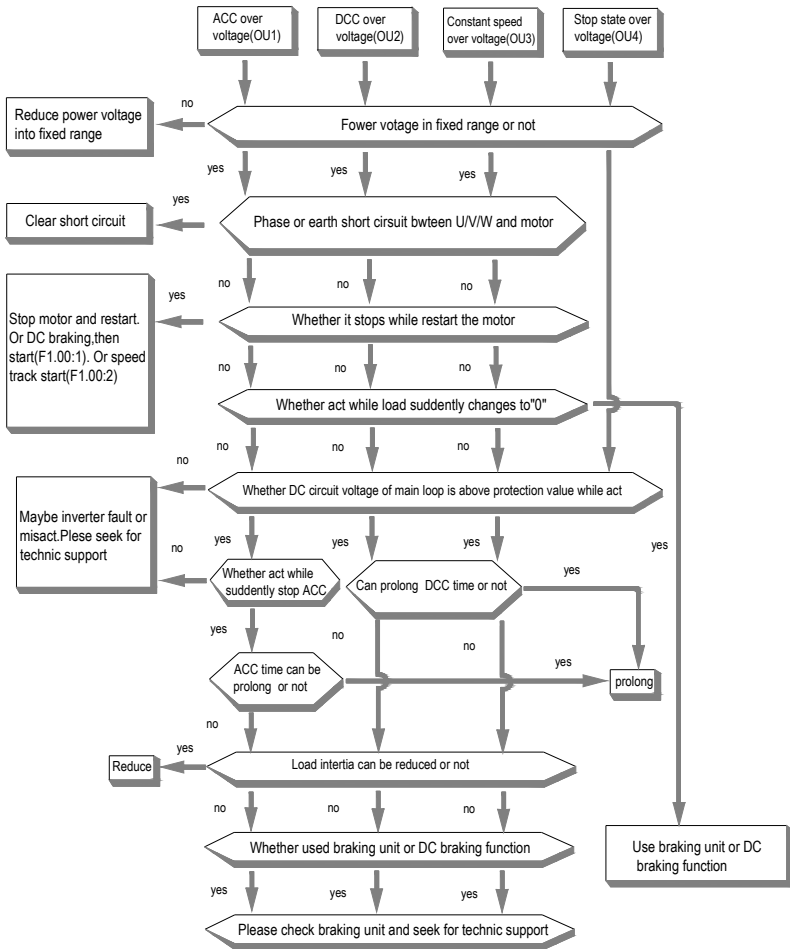

Supply voltage is too low

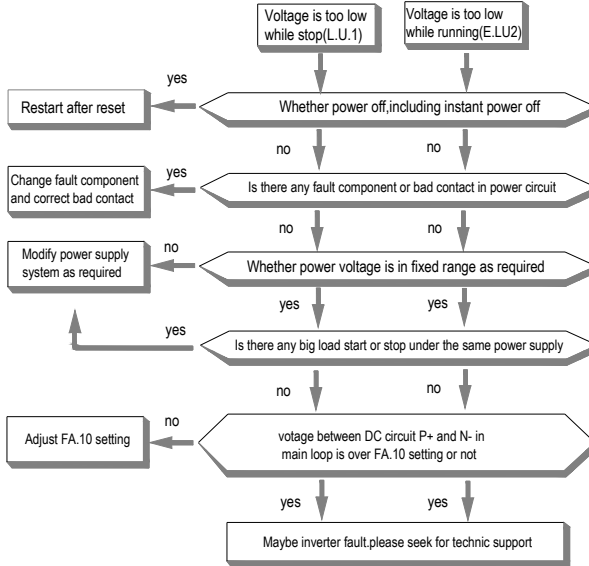

Inner inverter over heat

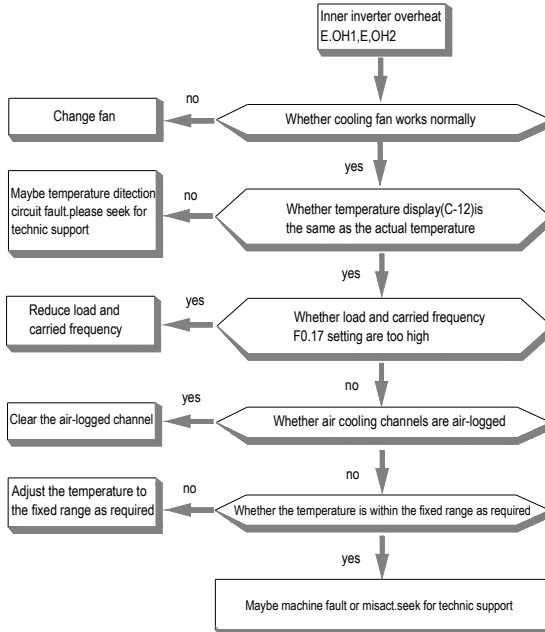

Over load

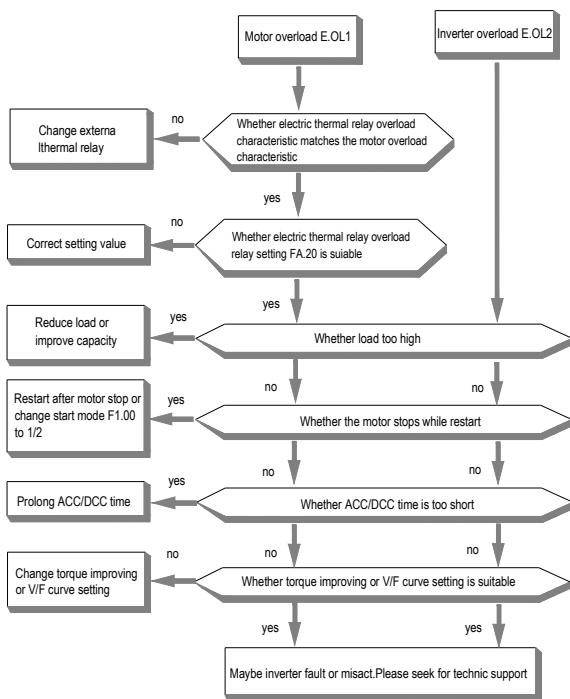

No display

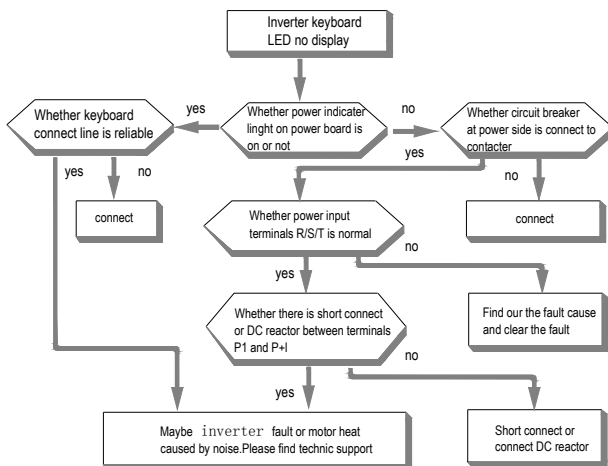

Motor heat

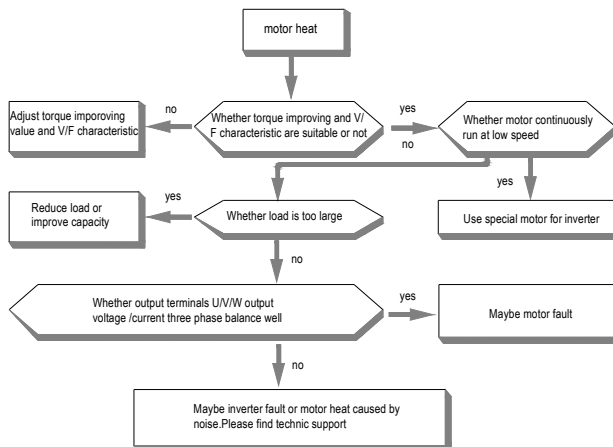

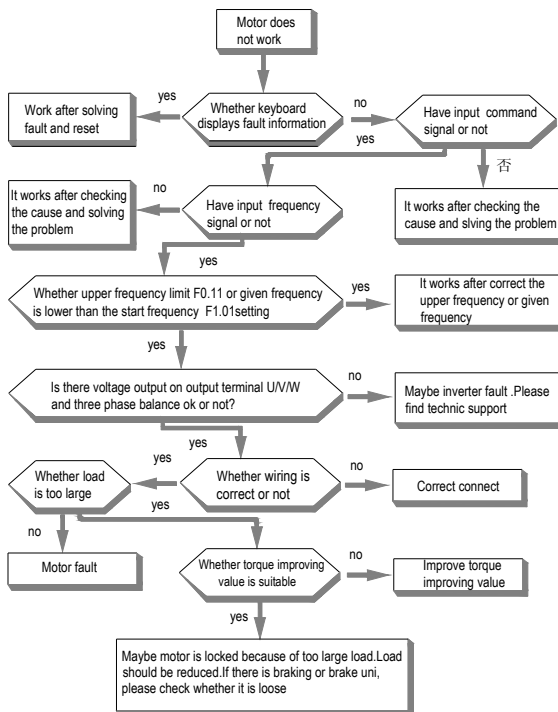

Motor does not rotate



Chapter 6 Periodic Overhaul and Maintenance

6.1 Safety Precautions

This chapter explains the safety rules in overhaul and maintenance.

	<ul style="list-style-type: none"> ● No operation under power connected state. Otherwise, there is danger of electric shock even death. ● Before operation, please cut all related equipments power, ensure that the main circuit DC current has dropped to safe range. And please operate after 5 mins.
	<ul style="list-style-type: none"> ● No operation while cover/panel is dismantled. Otherwise there is danger of electric shock even death. ● Do not dismantle the cover or PCB under power connected state. Otherwise there is danger of electric shock death. ● Only professional person can maintain or change fittings. Otherwise, there is danger. ● Do not wear loose clothes when install, debug, maintain. Related protective tools and safeguard should be adopted. ● Tighten screw according to named torque. If main circuit wire connection is loose, there is danger of overheat fire. ● Machine and motor earth must be reliable. Otherwise, there is danger of electric shock if touch the cover.
	<ul style="list-style-type: none"> ● While operation, please follow the ESD regulations. Otherwise, the inverter maybe damaged. ● Do not change the circuit or structure of the inverter. Otherwise, the inverter maybe damaged. ● Please confirm the rotate direction while no-load. Wrong direction can bring body injury or huge wealth loss. ● Do not use damaged machine. Otherwise, there is danger of accident.

6.2 Overhaul

Frequency inverter is composed by semi-conductive components, passive electronic component and motive component. All of these components have useful life. Even under normal working environment, some of the components can not work after the life time. To avoid malfunction, daily checking, periodic overhaul, component changing and other maintenance should be carried out to prevent. We suggest one overhaul every 3-4 months after installation. The overhaul period should be shortened while under cases as below.

- High temperature, high altitude;
- Start and stop frequently;
- AC power supply or load fluctuant badly;
- With serious vibration or impact;
- With dust, metal dust, salt, vitriol, chlorine;
- Bad storage environment;

● Daily checking

To avoid machine damage and to prolong life time, please check the following items everyday.

Items	Checking content	Treatment
Power supply	Check if power supply meets the requirement and whether there is lack-phase.	Treat it as nameplate explains.
Surroundings	Check whether it meets the table3-1 requirement.	Make sure the problem and solve it.
Cooling system	Check whether the inverter or the motor heat or change color abnormally and cooling fan working state.	Check whether it overload. Tighten screw. Check whether cooling fan is dirty or stall rotate.
Motor	Check if there is abnormal vibration or noise.	Tighten machine and electric connection and lubricate the machine components.
Load	Check whether output current is over the rated value of the motor or the inverter and has lasted for a period.	Make sure whether it overload and whether the machine model is right.



No operation under power connected state. Otherwise, there is danger of electric shock death. Before operating, please cut all related equipments power, ensure that the main circuit DC current has dropped to safe range. And please operate after 5 mins.

● Periodic overhaul

Under normal state, one overhaul every 3 or 4 months is ok. Please confirm the actual overhaul period according to the machine use condition and work circumstance while using the machine.

Main circuit

Items	Checking content	Treatment
Whole	Check insulated resistance; Check circumstance.	Tighten and change bad component; Clear and improve circumstance.
Electric connection	<ul style="list-style-type: none"> ● Check whether the wire and connector color changes, whether there is disrepair, crack color change or aging in insulated layer. ● Check whether the connect terminals are frayed, damaged or loose. ● Earth checking. 	<ul style="list-style-type: none"> ● Change bad wire. ● Fasten terminals and change bad terminals. ● Measure earth resistance and fasten earth terminals.
Mechanical connection	<ul style="list-style-type: none"> ● Check if there is abnormal vibration or noise or something is loose. 	<ul style="list-style-type: none"> ● Tighten, lubricate and change the bad components.
semi-conductive component	<ul style="list-style-type: none"> ● Check whether there is dust or rubbish. ● If there is obvious out change? 	<ul style="list-style-type: none"> ● Clean operation environment ● Change damaged component
Electrolytic capacitor	<ul style="list-style-type: none"> ● Whether there is liquid leak, color change or crack. Whether the safety valve outcrop, inflation, creak or liquid leak. 	<ul style="list-style-type: none"> ● Change damaged component

Peripheral equipment	<ul style="list-style-type: none"> ● Peripheral equipment outlook and insulation checking. 	<ul style="list-style-type: none"> ● Clear and change damaged component.
PCB	<ul style="list-style-type: none"> ● Peculiar smell color change, bad rust and connector checking. 	<ul style="list-style-type: none"> ● Fasten connector. ● Clear PCB. ● Change damaged PCB.
Cooling system	<ul style="list-style-type: none"> ● Check whether the fan is damaged or blocked up. ● Whether rubbish and dust is stuck to the heatsink. ● Is air inlet/outlet blocked? Or is there something sticking to the inlet/outlet. 	<ul style="list-style-type: none"> ● Clean operation environment. ● Change damaged component.
Keyboard	<ul style="list-style-type: none"> ● Whether it is damaged. Check whether display is complete. 	<ul style="list-style-type: none"> ● Change damaged component.
Motor	<ul style="list-style-type: none"> ● Check if there is abnormal vibration or noise. 	<ul style="list-style-type: none"> ● Tighten machine and electric connection and lubricate the machine components.



No operation under power connected state. Otherwise, there is danger of electric shock death. Before operating, please cut all related equipments power, ensure that the main circuit DC current has dropped to safe range. And please operate after 5 mins.

6.3 Maintenance

All equipments and components have useful life. Right maintenance can prolong the lifetime. But it can not avoid damage. Please change the components before their lifetime over.

Component	Useful lifetime
Fan	2~3year
Electrolytic capacitor	4~5 year
PCB	8~10 year

● Fan

While changing fan, please use original fan. You can contact Veichi company or the dealer. There are inverter models with many fans in one machine. To prolong these machines' lifetime, you had better to change all fans while changing the cooling fan.

● Fan change method:

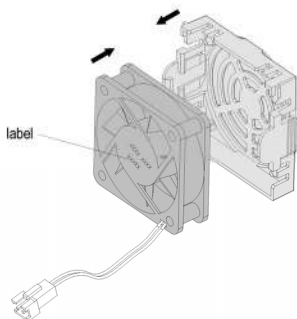

1. Install the fan vertically into the cover as shown in the picture (the label should face the outside).

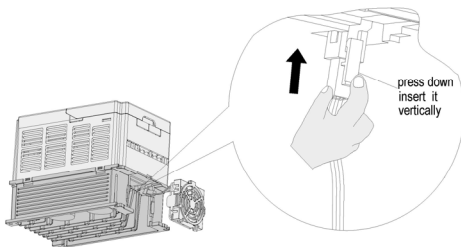

2. Press the elastic clip of the fan by finger toward the inner side and insert the leading terminal of the fan vertically by a little strength.

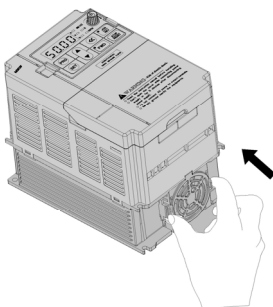

3. Insert the two elastic clips of the fan cover vertically into the fan installation slots.

● **Fan dismantlement:**

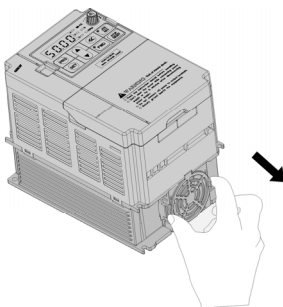

1. Pinch the two elastic clips of the fan and pull out. Then dismantle the fan cover.

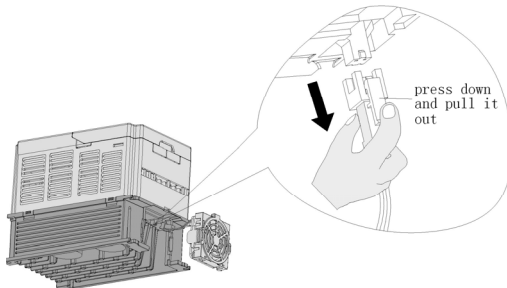

2. Press the elastic clip of the fan by finger toward the inner side and pull out the leading terminal of the fan vertically by a little strength.

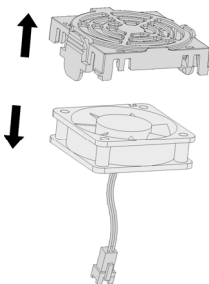

3. Poke the clips toward the outside and detach the fan from the cover by a little strength.



1. No operation under power connected state. Otherwise, there is danger of electric shock death. Before operating, please cut all related equipments power, ensure that the main circuit DC current has dropped to safe range. And please operate after 5 mins.
2. While the inverter is working, the heatsink temperature will be higher as the consumption. To prevent from scald, please do not touch the heatsink and do not change the fan until the temperature being safe.
3. To ensure the best performance of the inverter, please use the original fan.



● Other components

The replacement of the other components has strict requirements on maintenance technic and product familiarity. And they can not be used without strict detection after replacement. So we suggest the user not to replace the other inner components. If they need to change indeed, please contact to the dealer or the sales department of Shenzhen Veichi electric company.

Chapter 7 Peripheral Equipments and Options



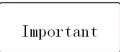

7.1 Safety Precautions











User must obey to the following safety rules and related requirements while using the peripheral equipments and selecting components.

	<ul style="list-style-type: none"> ● No operation under power connected state. Otherwise, there is danger of electric shock. ● Before operation, please cut all related equipments power, ensure that the main circuit DC current has dropped to safe range. And please operate after 5 mins.
	<ul style="list-style-type: none"> ● No operation while cover/panel is dismantled. Otherwise, there is danger of electric shock. ● Do not dismantle the cover or PCB under power connected state. Otherwise, there is danger of electric shock. ● Only professional person can install, debug or maintain the peripheral equipments and options. Otherwise, there is danger. ● Do not ware loose clothes when install, debug, maintain. Rated protective tools and safeguard should be adopted. ● Do not change wire, dismantle jumping wire, optional card, or change cooling fan while the inverter is running. Otherwise, there is danger of electric shock. ● Tighten screw according to named torque. If main circuit wire connection is loose, there is danger of overheat fire. ● Earth of the peripheral equipments and options must be reliable to prevent human body injury.
	<ul style="list-style-type: none"> ● While operation, please follow the ESD regulations. Otherwise, the inverter maybe damaged. ● Do not cut the power supply while the inverter is outputting voltage. Otherwise, the inverter maybedamaged.

7.2 Peripheral equipments

Normal peripheral equipments are showed as follows. To order the peripheral equipments, please consult our dealer or sales department.

Peripheral equipment		Functions
	Breaker	Protect power system and prevent malfunction impact other equipments working when short-circuit happens. And over-load protection.
	Leakage current breaker	Earth protection prevent electric shock(suggest to use the type which can prevent high-frequency leakage current)
	Electromagnetic contactor	Separate power and inverter indeed and realize basic relay control.
	AC input reactor	Improve power side factor and isolate the noise disturbance to the frequency inverter from the power side.

	DC reactor	Restrain ultraharmonics and improve power factor.
	Input side noise filter	Reduce frequency inverter disturbance to the power and reduce the power grid disturbance.
	Braking resistor	Passive energy consume unit of electric braking.
	Consumption braking unit	Electric braking control unit, controlling the braking resistance consume the regenerated electric power of the motor efficiently.
	Output side noise filter	Reduce the output side wire electromagnetic disturbance.
	Standby system	Standby system for inverter malfunction.
	Heat relay	Protect the motor while over load.
	0-phase reactor	Reduce electromagnetic disturbance of the frequency inverter (suitable for input/output side).
	Main loop surge absorbable unit	Restrain surge voltage while main loop switch components act.
	Winding surge absorbable unit	Restrain surge voltage when the AC contactor acts.

7.3 The use of peripheral equipments

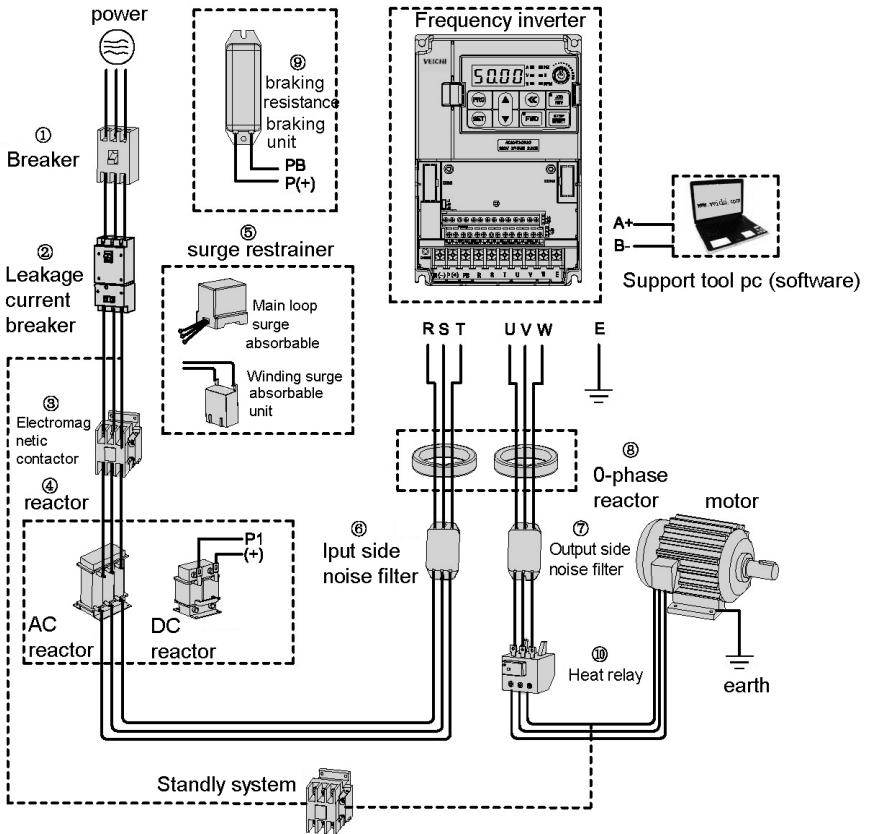

Chart 7-1: Peripheral equipments connection fig

Note:

① Wiring breaker

To ensure wiring safe, protect power system and prevent malfunction impact other equipments working when short-circuit happens, and protect while over-load, please do use wiring breaker between power supply and main loop power input terminals R,S,T.



While choosing the breaker, the capacitance should be about 1.5-2 times of the rated output current of the frequency inverter. Please compare the time characteristic of breaker and the characteristic of the inverter protection (150% of the rated output current, one minute). Make sure there will be no skip.



Before main loop wiring, make sure to cut the breaker and electromagnetic contactor. Otherwise, there is danger of electric shock.

② Leakage current breaker

The frequency inverter outputs peak voltage high-speed switch square wave, so there is high frequency leakage current. For earth protection to prevent electric shock and leakage current fire, please install leakage current breaker. Usually,

one frequency inverter will bring 100mA leakage current (while the power cable length is 1m). If the length prolongs 1m, there will be 5mA more leakage current. So please use leakage current breaker special for high frequency leakage at the power input side of the frequency inverter. The factors which impact leakage current are as follows:

Capacitance of inverter;

Carrier frequency;

Motor cable type and wire length;

MI/RFI filter.

To protect human body and inverter, please choose leakage current breaker which can use AC/DC power and can reply high frequency leakage current. There should be one leakage current breaker with more than 200mA sensitive current for every frequency inverter. If the frequency inverter outputs different wave, the high frequency leakage current will be higher, what will make the breaker malfunction. At this case, please take following treatments:

Improve the sensitive current of the leakage current breaker;

Reduce the carrier frequency of the inverter.

③ Electromagnetic contactor

Electromagnetic contactor is a peripheral equipment what is set to separate power and inverter connection. While inverter protective function is acting or carrying out emergency stop operation, the main loop power can be cut by peripheral equipment. Please do not connect the electromagnetic switch or electromagnetic contactor to output circuit. Otherwise, the inverter maybe damaged. While the power recovers after instant stop, if it needs to prevent the inverter to auto-restart, please install electromagnetic contactor for control at the input side.

④ AC input reactor and DC reactor

To restrain current sharp change and high hypo harmonic current, it needs to use AC input reactor and DC reactor. It can also improve power factor at the input side. In the following cases, AC input reactor or DC reactor must be used (use both will bring better effect).

Need to restrain ultraharmonics current and improve power side factor;

Need to switch input phase capacitance;

When frequency inverter is connected to large capacitance power transformer (600kVA above);

Silicon-controlled converters such as DC motor driver are connected to the same power system.

If user has higher requirement on other harmonic restraint, please connect the external DC reactor. Before connecting the external DC reactor, make sure to dismantle the short connector between the terminals P1 and (+).

⑤ Surge restrainer

Surge restrainer is divided to winding surge restrainer and main loop surge restrainer according to the use position. Please choose the right one which is suitable for the occasion. The aim of surge restrainer installation is restraining the surge voltage brought by switch components such as inductive load which is surrounding the frequency inverter (electromagnetic contactor, electromagnetic relay, electromagnetic valve, electromagnetic winding, electromagnetic detent). Do not connect the surge restrainer to the output side of the frequency inverter. Otherwise, the frequency inverter will be damaged.

⑥ Input side noise filter

Rectifier bridge of the inverter is uncontrolled rectifier. And input current is discontinuous impulse current. So the harmonic current noise signal, what flows to power wire from the inverter inner, maybe bring bad impact on the surrounding machines (radio, phone, noncontact switch, sensor). This time, we suggest to instal input side noise filter to lighten the noise into the power wire. Besides, it can also reduce noise from the power wire into the frequency inverter.



Please use the special noise filter for the frequency inverter and the connection wire between the filter and the inverter should be as short as possible.

⑦ Output side noise filter

The frequency inverter outputs square wave with high-speed peak value voltage switch. So there is high-speed dv/dt coner on the output cables that will produce a large number of radio disturbance and inductive signal. By installation

noise filter at the output side, the impact can be relieved. Please do not install the into phase capacitance and the noise filter to the output circuit. Otherwise, there is danger of damage to the frequency inverter.

⑧ 0-phase reactor

0-phase reactor is used for reducing the electromagnetic interference of the frequency inverter, which is suitable for the input side and output side. It equals to a three-phase common mode inductance. In actual use, according to the actual magnetic core size and cable specification, it is better to make sure 3-5 circles winding ratio to bring the best performance.

⑨ Braking reactor or braking unit

Renewable electricity consumption unit, please see the sixth part of the chapter three "electric installation".

⑩ Heat relay

Please install the heat relay at the output side of the frequency inverter. When the motor enters into overload state, it will cut the power source to protect the motor. While using one frequency inverter to drive one motor, it is unnecessary to install heat relay. The motor overload protection current [FA.20] of the frequency will work. While using one frequency inverter to drive multiple motors or the motor is drove directly by the power grid, please install heat relay between the inverter and the motor. While installing the heat relay, please design to cut the sequence control circuit of the MC at the main loop input side by the connection spot of the relay or design to input the heat relay action into the frequency inverter as the exterior malfunction. And please pay attention to the following tips to avoid heat relay malfunction and motor overheating at low speed.

Run at low speed

One frequency inverter run multiple motors

Motor cable is very long

Detect malfunction mistakenly for carrier frequency is too hig.

Low speed and heat relay

In normal case, the heat relay is suitable for the universal motor. While using the frequency inverter to run the universal motor (standard motor), the motor current is 5-10% higher, comparing with the commercial power supply. Besides, at low speed, even in the motor rated current range, the cooling capability of the fan drove by the motor axis will reduce, which will bring motor overheat. So please set the motor overheat protection current [FA.20] in the frequency inverter to be valid.

Motor cable is longer

While the motor cable is longer and the carrier frequency is higher, impacted by the leakage current, the heat relay maybe malfunction. To avoid it, please reduce the carrier frequency or set higher detection value of the heat relay. Before enhance the detection value, do confirm whether there is other cause for the motor overheat. Otherwise, there is danger.

Chapter 8 Quality Guarantee

8.1 Guarantee time and range

Guarantee time

Users can enjoy the following "three guarantee" service from the day of buying products if meeting products quality problem:

- We guarantee for repair, return and replacement for one month after delivery;
- We guarantee for repair and replacement for two months after delivery;
- We guarantee for repair for eighteen months after delivery;
- The articles above do not apply to export.

Guarantee range

Installation and debugging: In principle, it should be carried by users. Our company provides technical support. But we can afford installation and debugging service with charge.

On-site diagnosis: In principle, it should be carried by users. Our company gives technical support. But we can afford on-site diagnosis service with charge. According to diagnosis, if it is our liability, it will be free.

Malfunction maintain: While meeting malfunction, if it is quality problem and within guarantee time, we will repair free of charge. The malfunctions, caused by the reasons mentioned as follows, can only enjoy the paid service even if the product under warranty:

- The malfunctions caused by improper storage or faulty operation which are not in compliance with this user manual.
- The malfunctions caused by unauthorized transformation.
- The malfunctions caused by over-range operation.
- Have over guarantee time.
- The malfunctions caused by nature causes.

8.2 Liability exemption

Our company only takes on the liability according to our guarantee time and range. If you need more liability guarantee, you should buy proper commercial insurance from insurance company in advance. The other extended loss caused by malfunctions of our product is not within our guarantee range. Cases as follows, regardless of whether it is within guarantee time, it is not within our guarantee range. If need service, you has to pay for it.

- The malfunctions caused by improper storage or faulty operation.
- The malfunctions caused by unauthorized transformation.
- The malfunctions caused by over-range operation.
- Have been over guarantee time.
- The malfunctions caused by nature causes.
- User has not paid off the payment according to the contract.

8.3 Product application

- This product is not designed and produced for the case of vital importance.
- If need to apply this product in manned mobile machine, medical, aerospace, unclear energy, electric power, devices or system for submarine communications transit, please contact the sales department of our company. We do not take on the liability of the accident while this product is used in these cases without authorization.
- This product is produced under strict quality management. But we can not ensure that there will be no malfunction. If the user requires more safety requirement and reliability, standby device should be deployed. If the user need more guarantee, proper commercial insurance should be considered.

Chapter 9 Function Parameter specifications

9.1 Basic parameters

F0.00	Control way	Setting range: 0-3	Factory set: 0
-------	-------------	--------------------	----------------

0: VC without PG means vector control mode without speed sensor. It is used for all variable speed control. Please set this mode while need high accurate speed control.

Under this mode, even no motor feedback signal, torque cans response quickly. The motor can gain large torque even at low running speed.

1: V/F without PG control voltage/frequency ratio all can change speed. It is especially suitable for one frequency drive multi-motor application. It improves the current speed control system.

This mode is used for all speed control system while quick response and right speed control are unnecessary, or motor not clear or can't self study.

2: VC with PG means vector control mode with speed sensor. This mode is used for all speed control system that torque response is quick and needs high performance torque control. It can be for high accurate speed control to 0 speeds. To receive motor speed feedback signal, please use optional PG card.

It is mainly used for application requires strict control performance, such as: high accurate speed control system, high accurate torque control, simple servo control and so on.

3: V/F with PG can be used for simple speed feedback control. Please set this mode when need slow respond, but right speed control, especially occasions that PG feedback does not install on motor spindle, or occasions that motor not clear or can't self study.

Note: 1. PG: usually means photoelectricity inspects speed pulse encoder. While use other speed inspect card, other sensor can be used for speed feedback.

2. While choose VC control mode, before the first running, it has to input right motor parameters and motor parameters self adjust to gain right motor parameter. Please refer to details of F5 parameter groups.

3. Rightly setting VC control parameters to ensure good stable and dynamic control performance. For VC control parameter setting and adjustment, please refer to details of F6 parameter groups.

4. While choose VC control mode, all inverters can only drive one motor, and the capacitance rating difference between the inverters and the motor can't be too large. The inverter can be 2 rating bigger or 1 rating smaller than the motor. Otherwise, it will descend the control performance. Or the drive system can't run normally.

5. While choose VC with PG or V/F with PG control, must rightly set [F5.15--F5.17] parameters.

6. While choose V/F control mode must rightly set V/F control parameters F8.

F0.01	Control mode	Setting range: 0-1	Factory set: 1
-------	--------------	--------------------	----------------

0: Speed mode. Frequency control motor speed by control output frequency to control system speed.

Under vector control way, take speed precision control as aim to improve the motor features. For heavy load, the inverter output is controlled by the vector operation, so as to enhance the torque to change the output torque of the motor. For lighter loads, the inverter will quickly reduce output in order to ensure that the motor speed.

The inverter drives motor as ACC/DEC time setting to start. While accelerate to start, it ensures the fixed torque of the motor, at the same time ensures a smooth deceleration of motor torque while slow down.

The motor speed is determined by the inverter output frequency; Inverter maximum output torque is determined by the [F6.11]. Under speed control, the giving frequency settings and adjustments see parameters [F0.03 to F0.07].

Under vector control and speed control mode, response speed of the inverter to the external load changes can be improved by adjusting the ASR (speed loop), see parameter [F6.00 to F6.10].

1: Torque mode. Inverter takes the motor output torque as control objectives, and applies tension control needs occasions. Under torque control, the inverter output frequency is determined by the set torque and load torque. If the set torque is greater than the load torque, motor speed will increase; if the set torque is less than the load torque, motor speed will decrease.

Torque control is effective only when set as vector control without PG or with PG.

While take motor torque as the control aim, the F7 group parameters are valid. Torque giving set by the parameter [F7.00 to F7.03]. Under this mode, the frequency set channel is still valid, and used to limit the maximum speed of motor. While set torque is greater than the load resistance torque, motor speed will rise to set frequency as set acceleration time [F0.14], and limit at the set frequency value. Right acceleration time settings can effectively relieve the impact to the stretch material while motor speed rises. However, while the load resistance torque is greater than the set torque, the inverter make the motor quickly reduce the speed without the deceleration time impact; While the resistive torque and setting torque in balance, the inverter will allow motor steady speed running. Right set frequency to prevent the motor coaster phenomenon.

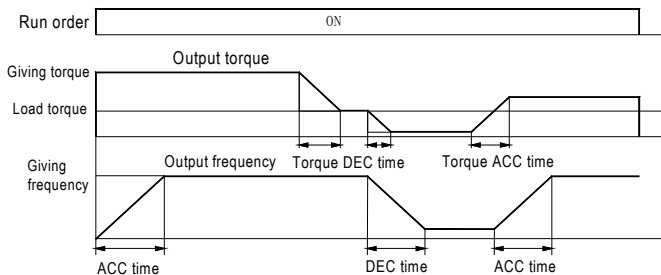

Relationship between torque and speed under

Tension control what is torque control aimed at set giving tension, is one function of torque control. No need tension sensor under this mode.

When the material tension is the control aim, the F7.00 is set to 7, then the the F9 parameter group is valid. The inverter can automatically calculate the output torque of the motor via parameters such as giving tension, roll diameter and mechanical drive ratio, suitable for the occasion needs tension control. Roll diameter is important parameter which must be gain under tension control. Roll diameter calculation method of the inverter includes the linear speed calculation, the thickness calculation, and time calculation. It can also receive analog signals, communications number given to get the current roll diameter. Details see parameters [F9.11]. You can use a variety of given mode for tension settings. While tension taper can be set to make it keeps tight-in-easy-out in the process of winding to ensure that rolling molding, detailed parameters [F9.01 to F9.06].

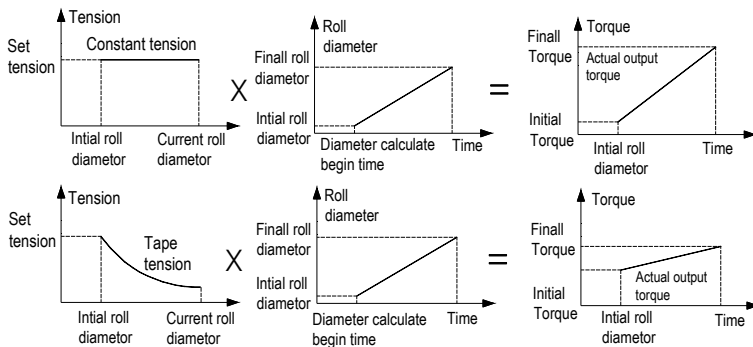

Tension control under torque control mode

Control mode: Choose right control mode base on need. The different features as below:

Control mode	0: Speed mode	1: Torque mode
Frequency and torque	Output frequency range: 0-upper limit frequency Output frequency is controlled by giving frequency. Output torque equal to load torque.	Output frequency range: 0-upper limit frequency Output frequency is not only limited by giving frequency, but also the load torque. While the out torque is bigger than the giving torque, frequency will reduce. Otherwise, the frequency is limited by the giving frequency.
Torque range	<p>250% torque</p> <p>F6.11 Max output torque</p> <p>20% torque</p> <p>Torque range under speed mode</p>	<p>200% Torque</p> <p>F7.06 upper torque limit</p> <p>F7.07 lower torque limit</p> <p>Torque range under torque mode</p>
Features and application	Take motor speed as aim, quick repond to load and keep stable speed. It is suitable where need exact speed.	Take motor output torque as aim; keep stable speed while with multi roll diameter calculation functions. It can be for constant tension and with tape winding and unwinding.

F0.02	Run command channel	Setting range: 0-3	Factory set: 0
-------	---------------------	--------------------	----------------

It is channel for inverter receiving run and stop order and run direction. It is only used for starting and stopping control under torque control.

0: Keyboard control Inverter run and stop is controlled by keyboard key **FWD**, **REV/JOG**, **STOP/RESET**. **REV/JOG** key is defined as reverse while **[F4.02]** set as "0" and jog while **[F4.02]** set as "1". Please refer to details of **[F4.02]**.

1: Terminal control Factory default as two line mode 1 control mode. Under two line mode 1, inverter run, stop and direction is controlled by whether "FWD" or "REV" set for **[F2.00-F2.07]** "multi function input terminal" connects to control board terminal (COM) or not. "FWD" and "REV" definition refer to **[F2.00-F2.07]**. While under other control mode, run, stop and direction refer to **[F2.12]**.

2: RS485 communication control Inverter run, stop and direction is controlled by the signal received by RS485 communication terminal. Details refer to FD communication control parameter group and appendix 2: RS485 communication protocol.

3: Optional card Inverter run, stop and direction is controlled by the signal received by optional card input signal. For the optional card installation, parameter setting and soon, please refer use manual packing with the optional card.

Note: 1. While fault reset, key STOP/RESET, control terminal reset order and RS485 communication terminal are valid reset order.

2. While inverter input frequency is 0Hz or lower than min output frequency [F1.26]. As long as you input run order, keyboard FWD indicator will be on, the motor will run as 0 frequency.

Clew: keyboard key STOP/RESET function can be selectable. Under exterior terminal control or communication control, it can be defined as stop function. Please refer to [F4.03]. Under exterior terminal control, if use STOP/RESET to stop, inverter stops and close exterior terminal run order. It needs to input exterior

terminal stop order and unlock. The exterior terminal run order will be valid again. So is the communication control.

F0.03	Frequency give main channel selection	Setting range: 0-12	Factory set: 0
-------	---------------------------------------	---------------------	----------------

It is used to select frequency given gain channel. The main and assistant channels relationship can be defined by parameter [F0.07].

0: Keyboard number setting Given frequency of the main channel is given and modified by [F0.08] keyboard numbers setting frequency. While parameter [F4.04] LED "0" digit "keyboard up/down key modification selection" is set as "1", no matter inverter is run or stop, [F0.08] setting value can be quickly modified by keyboard up/down key directly. Whether store the value modified by the shortcut key is decided by [F4.04] LED "00" digit.

1: Keyboard potentiometer given Main channel given frequency is given and modified by keyboard potentiometer. Please refer to [F4.07-F4.10] details for the relationship between keyboard potentiometer and frequency.

2: Terminal VS1 voltage analog Main channel given frequency is given and modified by (VS1) input analog. Please refer to [F3.00-F3.04] details for the relationship between input analog filter time and frequency.

3: Terminal VS2 voltage analog Main channel given frequency is given and modified by (VS2) input analog. Please refer to [F3.05-F3.09] details for the relationship between input analog filter time and frequency.

4: Terminal AS current analog Main channel given frequency is given and modified by (AS) input analog. Please refer to [F3.10-F3.14] details for the relationship between input analog filter time and frequency.

5: Terminal pulse signal Main channel given frequency is given and modified by (PUL) input pulse signal. Please refer to [F2.16-F2.21] details for the relationship between input pulse signal and frequency.

6:RS485 communication port: Main channel given frequency is given and modified by the signal accepted by RS485 communication port (A+) and (B-). Please refer to Fd communication control parameter groups and appendix 2: RS485 communication protocol details.

7: UP/DOWN control Main channel given frequency is given and modified by if UP terminal is connected to DOWN terminal or not, what is set by multi-function terminals (X1-X8). Anyone of the (X1-X8) terminals can be defined as UP and DOWN. Please refer to [F2.00-F2.07] details. UP, DOWN store and clear mode after adjustment can be set by [F2.22]. Please refer to [F2.22] details. ACC AND DEC of UP/DOWN control running given frequency is set by [F2.23]. UP/DOWN variation frequency can be cleared to 0 at any time by "UP/DOWN clear 0" terminal. Details see [F2.00-F2.07].

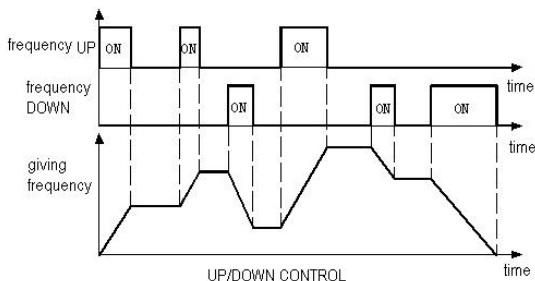

8: PID control given This channel is selected for PID closed loop control system. PID control is the control mode makes feedback the same as the target. Refer to PID control parameters "Fb".

Under this mode, while [F4.04] LED "0" digit is set as 3 by keyboard UP/DOWN key; [Fb.01] can be modified by UP/DOWN key. Whether save the modification is decided by [F4.04] LED "00" digit.

PID control state and trait are changed by multifunction terminals. Details refer to [F2.00-F2.07].

9: Program control (PLC) given Main channel given frequency and frequency running direction is controlled by inner

simple PLC control. Max 15 steps speed can be process control. Details see “FC” multi step, PLC function and swing frequency parameter group. If one step speed running time is set as “0”, it will jump over this step. It is convenient to set step speed. While [F0.07] LED “00” digit is 0, frequency control direction is invalid. While [F0.16] is set as 2—REV forbid and any step direction is set as REV, this step run as 0 speed. PLC and multi steps speed are both for frequency inverter vary speed and run under certain rules. Under multi steps running, step switch and direction change is control be the different combination between multi step control terminal and COM defined by multifunction input terminals. PLC not only can define one cycle of multi steps frequency in the function parameters. It can also define the run time, direction, ACC/DEC time and cycle mode of multi steps in the function parameters. Multi steps control terminal can be defined by any multifunction terminal. Details refer to [F2.00-F2.07].

10: Reserved

11: Optional card Main channel given frequency is controlled by input signal by optional card. For optional card installation, parameter setting please refers to user manual.

12: Terminal switch Frequency setting main channel is selected by frequency selection terminal which can be defined by any multi function terminal. See [F2.00-F2.07] please. Relation table between terminal state and frequency setting channel:

Frequency setting selection terminal 4	Frequency setting selection terminal 3	Frequency setting selection terminal 2	Frequency setting selection terminal 1	Frequency setting channel
OFF	OFF	OFF	OFF	Keyboard number give
OFF	OFF	OFF	ON	Keyboard potentiometer give
OFF	OFF	ON	OFF	Voltage analog VS1 give
OFF	OFF	ON	ON	Voltage analog VS2 give
OFF	ON	OFF	OFF	Voltage analog AS give
OFF	ON	OFF	ON	Terminal pulse PUL give
OFF	ON	ON	OFF	RS48 communication give
OFF	ON	ON	ON	UP/DOWN control
ON	OFF	OFF	OFF	PI control give
ON	OFF	OFF	ON	PLC give
ON	OFF	ON	OFF	Reserved
ON	OFF	ON	ON	Optional card

Combination details refer to multistep speed time order of “FC” parameter.

Note: valid combination of frequency selection terminal is 0-11(algorithm). Frequency inverter will output 0.00Hz if not within this range. “OFF”in the table means invalid. “ON” means valid.

F0.04	Main channel gain	Setting range: 0.000-5.000	Factory setting: 1.000
-------	-------------------	----------------------------	------------------------

It is used to magnify or reduce the main channel input signal, can adjust given frequency of main channel at prorate.

F0.05	Frequency give auxiliary channel selection	Setting range: 0-6	Factory setting: 1
-------	--	--------------------	--------------------

It is used to select auxiliary channel for frequency given, directly control or impact output frequency of frequency inverter. Relationship between main channel and auxiliary channel can be defined by [F0.07].

0: Keyboard number setting Given frequency of auxiliary channel is given and modified by [F0.08] keyboard number set frequency. While [F4.04] LED “0” digit is set as 1 by UP/DOWN key, [F0.08] can be quick modified by UP/DOWN key whether frequency inverter is running or stop. Whether save is decided by [F4.04] LED “00” digit.

1: Keyboard potentiometer Given frequency of auxiliary channel is given and modified by potentiometer. Detail refer to [F4.07-F4.10].

- 2: Terminal VS1 voltage analog** Given frequency of auxiliary channel is given and modified by control terminal (VS1). Input analog. Detail refers to [F3.00-F3.04].
- 3: Terminal VS2 voltage analog** Given frequency of auxiliary channel is given and modified by control terminal (VS2).input analog. Detail refer to [F3.05-F3.09].
- 4: Terminal AS current analog** Given frequency of auxiliary channel is given and modified by control terminal (AS).input analog. Detail refer to [F3.10-F3.14].
- 5: Terminal pulse signal** Given frequency of auxiliary channel is given and modified by control terminal (PUL).input analog. Detail refer to [F2.16-F2.21].
- 6: RS485 communication** Given frequency of auxiliary channel is given and modified by signal accepted by RS485 communication port (A+) and (B-) input analog. Detail refer to Fd communication control parameter group and appendix 2: RS485 communication protocol.

F0.06	Auxiliary channel gain	Setting range: 0.000-5.000	Factory set: 1.000
-------	------------------------	----------------------------	--------------------

It is used to magnify or reduce the main channel input signal, can adjust given frequency of main channel at prorate.

F0.07	Frequency give channels combinations mode	Setting range: 0000-0016	Factory set: 0000
-------	---	--------------------------	-------------------

LED "0" digit: ombination mode selection It is used to select the combination of the main input channel and the auxiliary input channel of the give frequency.

0: Main channel valid Only main channel [F0.03] is valid, auxiliary channel [F0.05] is invalid.

1: Auxiliary channel valid Only auxiliary channel [F0.05] is valid, main channel [F0.03] is invalid.

2: Main+auxiliary The sum of main channel [F0.03] adds auxiliary channel [F0.05] is the output frequency of the inverter.

3: Main-auxiliary The result of main channel [F0.03] minus auxiliary channel [F0.05] is the output frequency of the inverter.

4: MAX {main, auxiliary} The bigger one of main channel [F0.03] and auxiliary channel [F0.05] is the output frequency of the inverter.

5: MIN {main, auxiliary} The smaller one of main channel [F0.03] and auxiliary channel [F0.05] is the output frequency of the inverter.

6: Main*auxiliary Given frequency of main channel [F0.03] multiply certain percent which is percent of given frequency of auxiliary channel [F0.05] responding to max frequency [F0.09].The result is output frequency of the frequency inverter.

LED "00" digit: frequency control direction selection It is used to select whether permit negative frequency change the running direction of the frequency inverter while the result is negative.

0: invalid If result is negative, frequency inverter output 0.00Hz.

1: valid If result is negative, frequency inverter change running direction and output relative frequency.

LED "000" digit: reserved

LED "0000" digit: reserved

Note: 1. While main*auxiliary, frequency only count positive value. While any channel frequency is negative, count as 0.00Hz, frequency inverter output 0.00Hz.

2. Can't main+auxiliary while JOG and multi step speed running.

3. While rotate direction selection [F0.16] is set as REV forbid, whatever frequency control direction selection is set, frequency inverter outputs 0.00Hz frequency if count result is negative.

Note: Given frequency synthesized by main channel and auxiliary channel also limited by upper limit frequency

and lowest limit frequency.

F0.08	Keyboard number set frequency	Setting range: 0-upper limitation	Factory set: 50.00Hz
-------	-------------------------------	-----------------------------------	----------------------

While frequency give channel is keyboard numbers, it is used to set and modify frequency. If [F4.04] LED "0" digit is 1, the up/down key can modify the parameter value. Where save the modify after power off is decided by [F4.04] LED "00" digit.

F0.09	Max frequency output	Setting range: 0.00-320.00Hz	Factory set: 50.00Hz
F0.10	Upper limitation source selection	Setting range: 0-6	Factory set: 0
F0.11	Number give upper limitation	Setting range: Lowest limitation-max output frequency	Factory set: 50.00Hz
F0.12	Lowest limitation	Setting range: 0.00-upper limitation	Factory set: 0.00Hz
F0.13	Lowest limitation run mode	Setting range: 0-1	Factory set: 1

Max frequency output: The max frequency the frequency inverter permit to set. While [F1.13] LED "0" digit is 0, it is also the base of ACC/DEC time setting.

Upper limitation source selection: To select the give source of upper frequency limitation of frequency inverter. It is the max output frequency limitation set according to the machinery max rotate speed.

0: Number give Upper limitation set by [F0.11]. Max setting is small or equal to max frequency [F0.09]. Min setting is bigger or equal to min frequency [F0.12].

1: Keyboard potentiometer Upper limitation set by keyboard potentiometer.

2: Terminal VS1 voltage analog Upper limitation set by VS1 input analog.

3: Terminal VS2 voltage analog Upper limitation set by VS2 input analog.

4: Terminal AS current analog Upper limitation set by AS input analog.

5: Terminal pulse signal Upper limitation set by PUL input pulse frequency.

6: RS485 communication Upper limitation set by RS485 communication (H3004/H2004).Max set not over max frequency [F0.09]. Min set not lower than [F0.12]. Details refer to Fd communication control parameter group and appendix 2: RS485 communication protocol.

Note: Relation between input analog or PUL pulse frequency and upper limit frequency: when input max valid value, upper limit frequency is max frequency [F0.09]. When input min valid value, upper limit frequency is 0.00Hz.

Number give upper limitation: It is upper limit frequency given channel when [F0.10] is set as 0.

Lowest limitation: It is the lowest limitation of output frequency. While given frequency is lower than this value, [F0.13] decides the run frequency.

Lowest limitation run mode

0: Stop When actual given frequency is lower than the lowest limitation, inverter run as 0.00Hz.

1: Run as lowest limitation When actual given frequency is lower than the lowest limitation, inverter run as the lowest limitation.

Note: 1.While given upper limitation by analog or PUL pulse frequency, lowest limitation is invalid if upper limitation is lower than lowest limitation.

2. Max frequency, upper limitation and lowest limitation set carefully according to actual need please.

Except upper limitation and lowest limitation, inverter is also limited by parameters set such as start

frequency, free stop frequency, stop DC brake start frequency, jump frequency and so on. Max frequency, upper limitation and lowest limitation relationship as below:

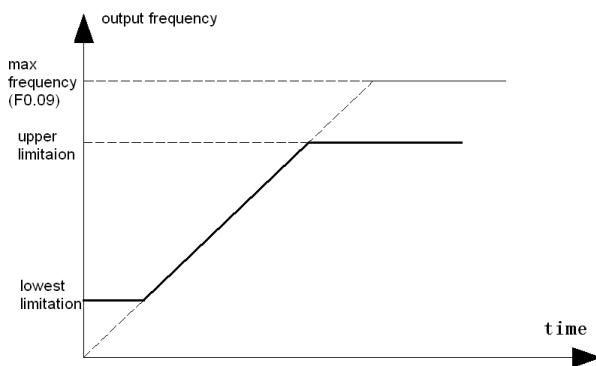

max frequency, upper limitation and lowest limitation relationship

F0.14	ACC time 1	Setting range: 0.01-650.00s	Factory set: Accord model
F0.15	DEC time 1	Setting range: 0.01-650.00s	Factory set: Accord model

ACC time 1: When [F1.13] LED "0" digit is 0, it means the time needed for output frequency accelerate from 0.00Hz to max frequency [F0.09]. When [F1.13] LED "0" digit is 1, it means the time needed for output frequency accelerate from 0.00Hz to 50.00Hz. Details refer to [F1.13].

DEC time 1: When [F1.13] LED "0" digit is 0, it means the time needed for output frequency decelerate from max frequency [F0.09] to 0.00Hz. When [F1.13] LED "0" digit is 1, it means the time needed for output frequency decelerate from 50Hz to 0.00Hz. Details refer to [F1.13].

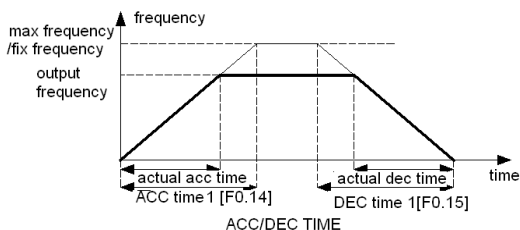

This frequency inverter can set 4 kinds of ACC/DEC time max. If need to select other ACC/DEC time group, it must to select by control terminal. Details refer to [F2.00-F2.07] and [F1.18-F1.23].

ACC time is only valid for normal speed up process, not including start per-excite, start DC brake time and start frequency hold time. DEC time is only valid for normal speed down process, not including stop DC brake time.

During process running, ACC/DEC time 1 is defined as first kind of ACC/DEC time. The other 3 kinds of ACC/DEC time details refer to [F1.18-F1.23] please.

JOG ACC/DEC time set by [F1.33, F1.34] alone.

F0.16	Rotate direction	Setting range: 0-2	Factory set: 0
-------	------------------	--------------------	----------------

0: Constant The actual run direction is the same as required. Not adjust the current direction.

1: Reverse The actual run direction is reverse to requirement. Adjust the current direction.

2: Forbid reverse While it is set as forbid, the reverse order of all run order channels (operation board, exterior terminal, RS485 communication, optional card and program running) is invalid.

When frequency setting is negative (including that after combination), no matter what is **[F0.07]** LED "00" digit (frequency control direction), the actual output frequency is limited as 0.00Hz.

Note: While reset to factory set, this setting is not changed.

Attention: All reverse order is forbid. If give reverse order, the frequency inverter not run.

F0.17	Carrier frequency	Setting range: 0.6-15.0kHz	Factory set: Accord model
-------	-------------------	----------------------------	---------------------------

It is used to set IGBT frequency, adjust electromagnetic noise, reduce leakage current. It is suitable for location need mute when run in high carrier frequency, main parts loss heavy. Machine is heat heavy. Effect is reduced. And power out small. Maintime, radio disturbance is heavy. And capacitance leak current more, if there is leak protection, maybe there is mistake action or over current.

While run in low carrier frequency, the case will be totally different. The best carrier frequency comes with adjustment base on actual case. The bigger the capacity, the smaller the carrier frequency should be.

We reserve the right of the biggest carrier frequency limitation.

Carrier frequency	noise	disturbance	Radiator temperature
low	big	Small	Small
↓	↓	↓	↓
high	small	big	big

Note: We advice ratio of carrier frequency to max frequency not lower than 36. If work under low frequency long time, we advice reduce carrier frequency to reduce the dead area time impact.

Attention: while carrier frequency is higher than the factory set, the rated power reduce 5% if carrier frequency add 1kHz.

F0.18	Carrier PWM frequency characteristic selection	Setting range: 0000-2111	Factory set: 0000
-------	--	--------------------------	-------------------

LED "0" digit:

0: Related to temperature

1: Not related to temperature

While temperature is too high, frequency inverter reduces carrier frequency automatic. Can reduce loss and avoid frequent alarm for over heat.

LED "00" digit:

0: Related to frequency output

1: Not related to frequency output

While carrier frequency is related to frequency output, it can automatic adjust carrier frequency according to frequency output. It can improve low frequency performance and high frequency mute effect.

LED "000" digit:

0: Fixed PWM Noise frequency is fixed.

1: Random PWM It can make humorous wave of output voltage distributes a wide range evenly to reduce noise and

vibration.

LED "0000": PWM wave mode

0: PWM mode 1 It output high quality sine wave while low speed to gain good low frequenc trait, low noise. It reduce parts on/off times to reduce loss while high speed. But the noise is big.

1: PWM mode 2 It gains high quality current wave. Noise is small, but loss is big and temperature rise up high.

2: PWM mode 3 It can reduce parts on/off times, reduce temperature rice up, but the noise is big.

F0.19	Parameter initialization	Setting range: 0-2	Factory set: 0
-------	--------------------------	--------------------	----------------

0: Not act

1: Recover factory setting

2: Clear malfunction records Clear all [FA.25-FA.44] mistake history.

Note: 1: Keyboard shows SRVE while recover factory setting. SRVE disappear while initialization finished.

2: Not change [F0.16] and [F4.11-F4.14] setting while recover factory setting.

3: If power off while recover factory setting. It can not finish. It need recover after power on again.

F0.20	AVR function selection	Setting range: 0-2	Factory set: 2
-------	------------------------	--------------------	----------------

0: Invalid

1: All valid

2: invalid while ACC, valid while other state

AVR is output voltage auto adjust function. When it is invalid, output voltage changes according to input voltage. When it is valid, output voltage keeps as setting if min input voltage is bigger than the output voltage setting (rated voltage). But output voltage reduces as input voltage reduced if min input voltage is lower than the rated output voltage.

9.2 Run control parameter

F1.00	Start-up mode	Setting range: 0-2	Factory set: 0
F1.01	Start pre-excitation time	Setting range: 0.00-60.00s	Factory set: Accord model
F1.02	Start frequency	Setting range: 0.00-60.00Hz	Factory set: 0.50Hz
F1.03	Start frequency hold time	Setting range: 0.0-50.0s	Factory set: 0.0s
F1.04	Braking current before start	Setting range: 0.0-150.0%	Factory set: 0.0%
F1.05	Braking time before start	Setting range: 0.0-30.0s	Factory set: 0.0s

Start-up mode:

0: Start by start-up frequency [F1.02] start-up frequency and [F1.03] start-up frequency hold time control the frequency inverter start. It is suitable for big static friction torque and small load inertia occasion or occasion with exterior machine brake equipment. Motor spindle can keep static before restart after stop.

1: DC brake and start. Firstly [F1.04] brake current and [F1.05] brake time give certain energy to motor with load (electromagnetic hold brake). Then start by start-up frequency. It is suitable for stop state, small inertia load with REV and FWD.

2: Speed track, direction judge and start Detect speed and direction firstly, then start as the speed detected out and run to given frequency according to ACC/DEC time.

Control mode Track mode	VC without PG	V/F without PG	VC with PG (PG input)	VC with PG (PUL input)	V/F with PG (PG input)	V/F with PG (PUL input)
Inner track	Valid	Valid		Valid		Valid
Out track			Valid		Valid	

Start pre-excitation time: It is used to set pre-excitation time for asynchronism motor while start. It can improve start performance and reduce start current and start time.

Start frequency: It is the initial output frequency while start. Right start frequency can bring big start torque. While start, certain instant force can be brought for load with big static friction under static state.

Start frequency hold time: How long the start frequency be hold.

Braking current before start: It is the braking current that the inverter gives the motor while DC braking. It is based on the output rated current of the inverter. Only when [F1.00] is 1, there is DC braking while start.

Braking time before start: It is the time that DC braking current hold while start. Only when [F1.00] is 1, there is DC braking while start. There is no DC braking while braking time is 0.0s.

Attention: Start frequency is not limited by [F0.12], but limited by [F1.26] min output frequency. If setting is smaller then [F1.26], the output frequency is 0.00Hz.

Note: Under process of REV/FWD switch while normal running or process of frequency setting change while up/down running, frequency inverter starts from or reduces to min output frequency [F1.26] and than output 0.00Hz.

Note: In process of inverter start ACC, inverter output 0 when given frequency is small then starts frequency.

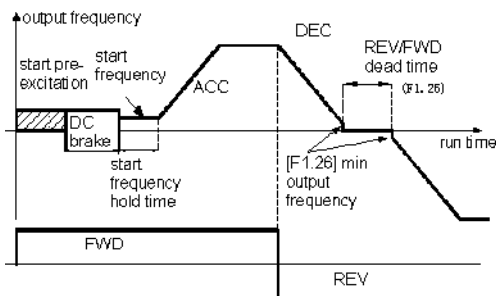

START UP FIG

F1.06	Speed track waiting time	Setting range: 0.00-60.00s	Factory set: Accord model
-------	--------------------------	----------------------------	---------------------------

It is defined as the waiting time before speed tracking while receiving the run order. After this time, inverter runs to give frequency according to the frequency and direction detected out and the ACC/DEC time setting.

For big inertia load, prolong speed track waiting time to reduce the instant impact current.

F1.07	Stop mode	Setting range: 0-1	Factory set: 0
-------	-----------	--------------------	----------------

0: DEC to stop ACC to 0.00Hz and stop output. While give frequency is small then stop DC braking start frequency [F1.08], inverter output frequency will change to 0. DC brake and stop work. Otherwise inverter wills DEC to min output

frequency and stop work.

For inverter with build in braking unit (under than AC90-T3-018T, braking resistance (optional) can be used. When DC bus voltage is over **[FA.08]** energy braking act voltage, inverter begins to carry out the energy braking act.

For inverter without build in braking unit (upper than AC90-T3-022T), braking unit and braking resistance can be selected. It is mainly used for occasion that need quick braking while stop.

1: Free stop Inverter stop output while receiving the stop order. Usually, it cooperates with exterior machine hold brake.

F1.08	Initial frequency of stop DC braking	Setting range: 0.00-50.00Hz	Factory set: 0.00Hz
F1.09	Stop DC braking current	Setting range: 0.0-150.0%	Factory set: 0.0%
F1.10	Waiting time of stop DC braking	Setting range: 0.0-60.0s	Factory set: 0.0s
F1.11	Stop DC braking duration	Setting range: 0.0-60.0s	Factory set: 0.0s

Initial frequency of stop DC braking: While inverter DEC to this frequency, it will stop output and start DC braking.

Stop DC braking current: It is the current that inverter give motor while DC braking. It is based on the output rated current of the inverter. DC braking can afford 0 speed torque. It is usually used for improve stop accuracy and quick stop. It can't be used for DEC braking for normal running.

Waiting time of stop DC braking: It is the time for waiting to DC braking while inverter DEC to initial frequency of stop DC braking and stop output.

Stop DC braking duration: It is DC braking current holding time after stop. It is no DC braking process while braking time is 0.0s.

F1.12	Reserved
-------	----------

F1.13	ACC/DEC mode selections	Setting range: 0000-0011	Factory set: 0000
F1.14	Start ACC rate of S curve	Setting range: 20.0%-100.0%	Factory set: 50.0%
F1.15	Start DEC rate of S curve	Setting range: 20.0%-100.0%	Factory set: 50.0%

ACC/DEC mode selections

LED "0" digit: ACC/DEC time base

0: max frequency Base is max frequency **[F0.09]**.

1: fixed frequency Base is 50.00Hz.

LED "00" digit: ACC/DEC mode

0: Beeline Suitable for general used load.

1: S Curve Suitable for load need reduce noise, vibration, impact or load need descend torque for low frequency and ACC short time for high frequency. If over current or over load while start, please increase **[F1.14]** setting.

LED "000" digit: reserved

LED "0000" digit: reserved

Start ACC rate of S curve: It is the rate while start ACC. The smaller the rate is, the ACC S curve is sharper. Otherwise, The bigger the rate is, the ACC S curve is more like a beeline. If you want it ACC more smoothly, you can reduce the rate and prolong ACC time.

Start DEC rate of S curve: It is the rate while start DEC. The smaller the rate is, the DEC S curve is sharper. Otherwise, The bigger the rate is, the ACC S curve is more like a beeline. If you want it DEC more smoothly, you can reduce the rate and prolong DEC time.

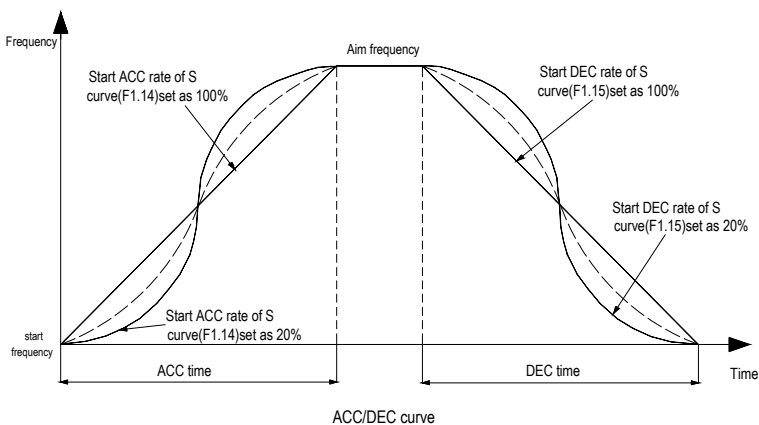

F1.16-F1.17	Reserved
-------------	----------

F1.18	ACC time 2	Setting range: 0.00-650.00s	Factory set: 10.00s
F1.19	DEC time 2	Setting range: 0.00-650.00s	Factory set: 10.00s
F1.20	ACC time 3	Setting range: 0.00-650.00s	Factory set: 10.00s
F1.21	DEC time 3	Setting range: 0.00-650.00s	Factory set: 10.00s
F1.22	ACC time 4	Setting range: 0.00-650.00s	Factory set: 10.00s
F1.23	DEC time 4	Setting range: 0.00-650.00s	Factory set: 10.00s

ACC time 2/3/4: When [F1.13] LED "0" digit is 0, it means the time need for output frequency ACC from 0.00Hz to max frequency [F0.09]. When [F1.13] LED "0" digit is 1, it means the time need for output frequency ACC from 0.00Hz to 50.00Hz. Details refer to [F1.13].

DEC time 2/3/4: When [F1.13] LED "0" digit is 0, it means the time need for output frequency DEC from max frequency [F0.09] to 0.00Hz. When [F1.13] LED "0" digit is 1, it means the time need for output frequency DEC from 50.00Hz to 0.00Hz.

ACC/DEC time details refer to [FC.31-FC.45].

JOG ACC/DEC time is set by [F1.33, F1.34]

ACC/DEC time table:

Terminal 2	Terminal 1	ACC/DEC time
OFF	OFF	ACC/DEC time 1
OFF	ON	ACC/DEC time 2
ON	OFF	ACC/DEC time 3
ON	ON	ACC/DEC time 4

If any unclear, please see FC parameter group multi steps time order fig.

F1.24	Emergency stop DEC time	Setting range: 0.01-650.00s	Factory set: 10.00s
-------	-------------------------	-----------------------------	---------------------

Same as ACC/DEC time definition.

Emergency stop can be take effect by emergency stop terminal; details refer to [F2.00-F2.07]. While terminal control two line run, whether carry out the original run order is decided by [2.13] LED "00" digit. Details refer to [F2.13].

If [FA.01] "000" and "0000" digit is 1 emergency stop, the inverter wills DEC to stop according this time and alarm fault. Details refer to [FA.01].

While multifunction terminal is set as emergency stop, refer to detail [F2.29-F2.31].

F1.25	FWD&REV dead area	Setting range: 0.0-120.0s	Factory set: 0.0s
F1.26	Min output frequency	Setting range: 0.00-60.00Hz	Factory set: 0.50Hz

FWD&REV dead area: Waiting time at 0.0Hz while switch between FWD/REV. It sets for equipment with machine dead area while big inertia load and change direction.

Min output frequency: If lower than this frequency, inverter output 0.00Hz.

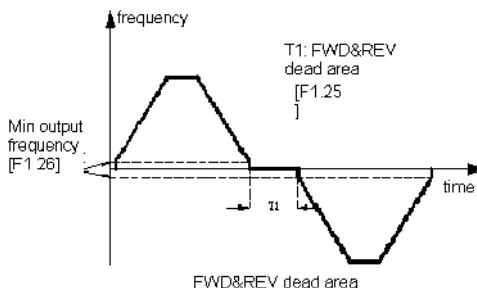

F1.27	0 speed hold torque	Setting range: 0.0-150.0%	Factory set: Accord model
-------	---------------------	---------------------------	---------------------------

Set output torque at 0 speeds.

F1.28	0 speed torque keep time	Setting range: 0.0-500.0s	Factory set:5.0s
-------	--------------------------	---------------------------	------------------

It sets the torque keep time while running at 0 speed.Begin time while run frequency is 0Hz. Inverter stop output while 0 speed torque keep time arrives.

Right set this time can save energy effectively while protect motor

F1.29	Power off restart action selection	Setting range: 0-1	Factory set: 0
F1.30	Power off restart waiting time	Setting range: 0.00-650.00s	Factory set: 0.50s

Power off restart action selection

0: invalid Only run with order power on again.While keyboard control, RS485 communication control or optional card control, automatic clear running order while power off.

While exterior terminal control, run as [F1.31] setting.

1: Valid If inverter is at run state before power off, it start automatically after [F1.30] waiting time. While waiting, it does not accept any orders. But if stop order, it will not restart.

Note: It can make machine automatic re-start while power recovers. Please use it carefully.

Power off restart waiting time: While [F1.29] is valid, inverter restarts after [F1.30] waiting time.

F1.31	Terminal running protection selection	Setting range :0000-0011	Factory set: 0011
-------	---------------------------------------	--------------------------	-------------------

LED "0" digit: while electrify

0: Terminal running order invalid while electrify Terminal controls stop firstly, then start.

1: Terminal running order valid while electrify Terminal controls start directly.

LED "00" digit: while switch the run order give channel

0: invalid Terminal controls stop firstly, then start.

1: valid Terminal controls start directly.

F1.32	JOG running frequency setting	Setting range: 0.00-Max frequency	Factory set: 5.00Hz
F1.33	JOG ACC time	Setting range: 0.00-650.00s	Factory set: 10.00s
F1.34	JOG DEC time	Setting range: 0.00-650.00s	Factory set: 10.00s

JOG running frequency setting: Set output frequency while JOG.

JOG ACC time: When [F1.13] LED "0" digit is 0, it means the time need for output frequency ACC from 0.00Hz to max frequency [F0.09]. When [F1.13] LED "0" digit is 1, it means the time need for output frequency ACC from 0.00Hz to 50.00Hz. Details see [F1.13].

JOG DEC time: When [F1.13] LED "0" digit is 0, it means the time need for output frequency DEC from max frequency [F0.09] to 0.00Hz. When [F1.13] LED "0" digit is 1, it means the time need for output frequency DEC from 50.00Hz to 0.00Hz.

Note: JOG run frequency set is only limited by [F0.09]. While JOG frequency setting is bigger then [F0.11] upper limitation, actual JOG output frequency is limited by upper limitation. Only terminal JOG priority is not limited by run orger channels. Other JOG orders have priority only while the channel is tha same as others. Such as keyboard JOG is only valid under keyboard control.

F1.35	Jump frequency	Setting range: 0.00-Max frequency	Factory set: 0.00Hz
F1.36	Jump frequency range	Setting range: 0.00-Max frequency	Factory set: 0.00Hz

Jump frequency: While running, the frequency avoid running.

Jump frequency range: The up/down frequency range of [F1.35] avoid running.

It can be used for output frequency to avoid machine load resonance point.

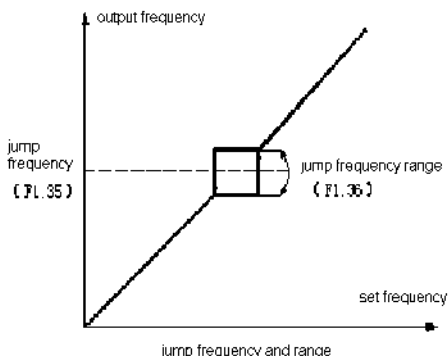

Note: Output frequency will through jump frequency area while ACC/DEC.

9.3 Quantum digital terminal functions

F2.00	Multifunction input terminal 1(X1)	Setting range: 0-57	Factory set:1
F2.01	Multifunction input terminal 2(X2)		Factory set:2
F2.02	Multifunction input terminal 3(X3)		Factory set:4
F2.03	Multifunction input terminal 4(X4)		Factory set:5
F2.04	Multifunction input terminal 5(X5)		Factory set:6
F2.05	Multifunction input terminal 6(X6)		Factory set:8
F2.06	Multifunction input terminal 7(X7)		Factory set:56
F2.07	Multifunction input terminal 8(X8)		Factory set:57

Multifunction terminal (X1-X8) function can be defined by **[F2.00-F2.07]**. And trait and filter time can be defined by **[F2.08-F2.11]**. Setting and function table:

setting	setting	setting	setting
0	No function(can choose again)	29	PID give switch 2
1	FWD	30	PID give switch 3
2	REV	31	PLC pause
3	3 line run control(Xi)	32	PLC restart
4	FWD JOG	33	Swing frequency in
5	REV JOG	34	Swing frequency pause
6	Free stop	35	Swing frequency seset
7	Emergency stop	36	Frequency channel switch terminal 1
8	Fault reset	37	Frequency channel switch terminal 2
9	Out fault input	38	Frequency channel switch terminal 3
10	Frequency (UP)	39	Frequency channel switch terminal 4
11	Freuqncy (DW)	40	Timer touch terminal
12	(UP/DW clear)	41	Timer clear terminal
13	Reserved	42	Counter clock input terminal
14	Reserved	43	Counter clear terminal
15	Multi steps terminal 1	44	DC brake order
16	Multi steps terminal 2	45	Pre-excitation order terminal
17	Multi steps terminal 3	46	Reserved
18	Multi steps terminal 4	47	Start magnetic particle clutch function
19	ACC/DEC time selection terminal 1	48	PID parameter switch terminal 1
20	ACC/DEC time selection terminal 2	49	PID parameter switch terminal 2
21	ACC/DEC pause	50	Initial roll diameter setting terminal 1
22	PID control cancel	51	Initial roll diameter setting terminal 2
23	PID control pause	52	Linear speed selection terminal
24	PID trait switch	53	Material thickness selection terminal
25	PID give switch 1	54	Full roll diameter selection terminal
26	PID give switch 2	55	Empty to full roll time selection terminal
27	PID give switch 3	56	Roll diameter reset terminal
28	PID give switch 1	57	Roll diameter calculation pause

0: No function This terminal invalid.

1: FWD While run order is given by terminal, and **[F2.12]** is set as 2 lines 1, and terminal is valid, inverter will FWD. Other control mode refers to **[F2.12]**.

2: REV While run oder is given by terminal, and **[F2.12]** is set as 2 lines 1, and terminal is valid, inverter will REV. Other control mode refers to **[F2.12]**.

3: 3 lines run control (Xi) While run oder is given by terminal, and **[F2.12]** is set as 3 lines 1/2, it is 3 lines run control (Xi). Details refer to **[F2.12]**.

4: FWD JOG

5: REV JOG

6: Free stop While it is valid, inverter stops output. Motor will free run. While free stop terminal is always valid; inverter does not accept any start order and keep stop state. Whether recover to original order after free stop order is relieved while terminal 2 line control running, refer to [F2.13] please. It does not recover to original order after free stop order is relieved while keyboard, RS485, optional card and terminal 3 line control running. If need start inverter, it needs to input run order again.

7: Emergency stop If input emergency stop order while running, inverter DEC and stop according [F1.24] DEC time setting. Details refer to [F1.24]. It can not run again before totally stopping. While [F1.07] is set as free stop, emergency stop order and free stop order is same function. Once this terminal is valid, inverter stops output and free stop immediately. If emergency stop terminal is always valid, inverter does not accept start order and keep stop. Under 2 line control mode, whether recover original run order after relieve emergency stop order is decided by [F2.13]. Not recover original order under keyboard, RS485, optional card and terminal 3 line control mode. If need start inverter, please input order again.

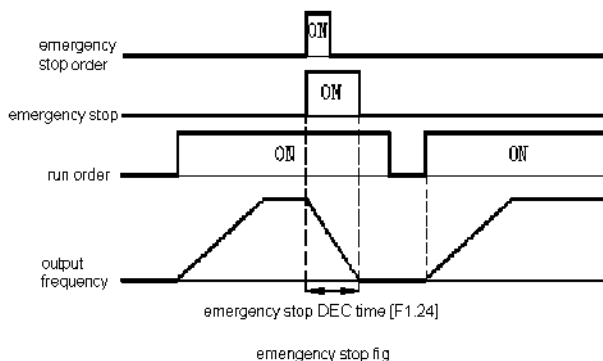

Note: While use emergency stop function, please set right [F1.24] DEC time or work with energy brake function. Otherwise over-voltage fault maybe happen.

8: Fault reset It decides whether reset fault while alarm. Whether recover original order after fault reset is decided by [F2.13].

9: Out fault input Inverter stop output while accept exterior fault input signal by it. Motor free run and display malfunction information E.EF.

10: Frequency (UP)

11: Frequency (DW)

Only valid while [F0.03] is set as 7. Details refer to [F0.03].

12: (UP/DW clear) Only valid while [F0.03] is set as 7. Details refer to [F0.03].

13: Reserved

14: Reserved

15: Multi steps terminal 1

16: Multi steps terminal 2

17: Multi steps terminal 3

18: Multi steps terminal 4

See parameter details of multi steps and FC group of PLC.

19: ACC/DEC time selection terminal 1

20: ACC/DEC time selection terminal 2

ACC/DEC time selection terminal 1 is defaulted as valid while not set parameter and terminal invalid. Details see [F1.18-F1.23].

21: ACC/DEC pause In ACC/DEC process, if it is valid, inverter stops ACC/DEC and keeps the speed. It is only valid while inverter is running. It is invalid for DEC stop.

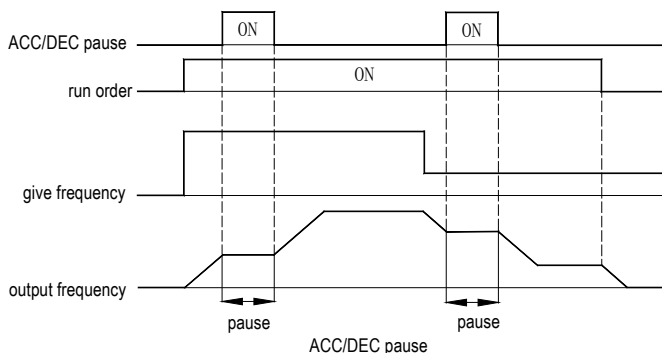

22: PID control cancel While [F0.03] is set as 8 and this terminal is valid, it can make PID function be invalid. Main frequency given channel gives 0.00Hz. While this terminal is invalid, PID re-count frequency given of main channel.

23: PID control pauses While PID given and this terminal is valid, it can make PID adjustment be invalid and keep frequency not change. PID re-counts frequency given of main channel.

24: PID trait switch While [F0.03] is set as 8 and this terminal is valid, [Fb.05] LED "0" digit-trait setting will be changed. PID output trait back to [Fb.05] LED "0" digit-trait setting.

25: PID given switch 1

26: PID given switch 2

27: PID given switch 3

While PID controller give signal source [Fb.00] is set as 8, give signal source PID channel can be switched by this group of terminals. Details see [Fb.00].

28: PID given switch 1

29: PID given switch 2

30: PID given switch 3

While PID controller feedback signal source [Fb.02] is set as 8, feedback signal source channel can be switched by this group of terminals. Details refer to [Fb.02].

31: PLC pause While [F0.03] is 9, this valid signal can make PLC pause and inverter output 0.00Hz. Inverter go on as before while this signal disappears. See parameter details of multi steps and FC group of PLC.

32: PLC restart While [F0.03] is 9, this valid signal can make PLC start from the 1st step again at stop state or running. See parameter details of multi steps and FC group of PLC.

33: Swing frequency in Under swing frequency control, while set as manual swing frequency in and this terminal is valid, swing frequency function is valid. And inverter begins swing frequency running. Details see [FC.48-FC.54].

34: Swing frequency pause Under swing frequency control, while this terminal is valid, inverter keeps frequency not change and recover to swing frequency run after terminal order is cancelled. Details see [FC.48-FC.54].

35: Swing frequency seset Under swing frequency control, while this terminal is valid, inverter back to center frequency and recover to swing frequency run after terminal order is cancelled. Details see [FC.48-FC.54].

36: Frequency channel switch terminal 1

37: Frequency channel switch terminal 2

38: Frequency channel switch terminal 3

39: Frequency channel switch terminal 4

It is valid only when [F0.03] is set as 12. Main frequency input channel is selected by terminal. 4 terminals can be combined to 0-11 which is corresponding to frequency input channels 0-11 of [F0.03]. Details refer to [F0.03].

40: Timer touch terminal Closed is valid. Detail refer to [F2.25-F2.26].

41: Timer clear terminal Closed is valid. Detail refer to [F2.25-F2.26].

42: Counter clock input terminal Detail refer to [F2.27-F2.28].

43: Counter clear terminal Closed is valid. Detail refer to [F2.27-F2.28].

44: DC brake order At stop state, it can start DC brake function. Details refer to [F1.09]. If input run order or JOG order, DC braking will be stopped.

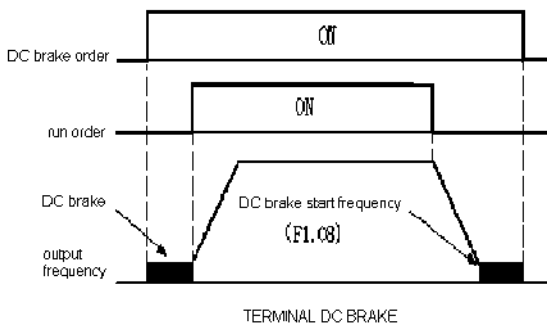

45: Pre-excitation order terminal At stop state, it can start pre-excitation function. If input run order or JOG order, pre-excitation order is cancelled.

46: Reserved

47: Start magnetic particle clutch function While it is valid, the inverter will start the magnetic particle clutch function. Details see [F7.14-F7.17].

48: PID parameter switch terminal 1

49: PID parameter switch terminal 2

50: Initial roll diameter setting terminal 1 Two different terminals combination corresponds to different initial roll diameter only when parameter [F9.14] is set as "0"(terminal selection) in diameter calculation. Details see [F9.15-F9.17].

51: Initial roll diameter setting terminal 2 Two different terminals combination corresponds to different initial roll diameter only when parameter [F9.14] is set as "0"(terminal selection) in diameter calculation. Details see [F9.15-F9.17].

52: Linear speed selection terminal It is valid only when parameter [F9.14] is set as "1"(calculate by linear speed) in diameter calculation. This terminal can make the switch between linear speeds setting 1 and linear speed setting 2 coming ture. Details see [F9.28-F9.29].

53: Material thickness selection terminal It is valid only when parameter [F9.14] is set as "2"(calculate by thickness) in diameter calculation. This terminal can make the switch between material thickness 1 and material thickness 2 coming ture. Details see [F9.40-F9.41].

54: Full roll diameter selection terminal It is valid only when parameter [F9.14] is set as "3"(calculate by time) in diameter calculation. This terminal can make the switch between empty roll to full roll time 1 and full roll to empty roll time 2 coming ture. Details see [F9.44-F9.45].

55: Empty to full roll time selection terminal It is valid only when parameter [F9.14] is set as "3"(calculate by time) in diameter calculation. This terminal can make the switch between empty roll to full roll time 1 and full roll to empty roll

time 2 coming ture. Details see [F9.46-F9.47].

56: Roll diameter reset terminal In diameter calculation, set [F9.18] as "0" (roll diameter manual reset) and this parameter is valid, inverter will back the roll diameter to initial value.

57: Roll diameter calculation pause In diameter calculation, while this parameter is valid, inverter will stop roll diameter calculation.

F2.08	X1-X4 terminal trait selection	Setting range: 0000-1111	Factory set: 0000
F2.09	X1-X4 input terminal filer time	Setting range: 0.000-60.000s	Factory set: 0.010s

X1-X4 terminal trait selections

LED "0" digit: X1 terminal

0: On valid

1: Off valid

LED "00" digit: X2 terminal

0: On valid

1: Off valid

LED "000" digit: X3 terminal

0: On valid

1: Off valid

LED "0000" digit: X4 terminal

0: On valid

1: Off valid

X1-X4 input terminal filer time: When input terminal state changes, only if changed state keeps after filter time setting, it is considered as valid terminal state change. Otherwise, it keeps last state to effectively avoid misact caused by disturbance.

F2.10	X5-X8 terminal trait selection	Setting range: 0000-1111	Factory set: 0000
F2.11	X5-X8 input terminal filer time	Setting range: 0.000-60.000s	Factory set: 0.010s

Same as F2.08 and F2.09.

F2.12	Terminal control mode	Setting range: 0-3	Factory set: 0
-------	-----------------------	--------------------	----------------

0:2-line 1 Run and direction in 1.Factory set is X1(FWD), X2(REV) terminals decide motor forward or reverse.

K1	K2	run order
0	0	stop
1	0	FWD
0	1	REV
1	1	COM

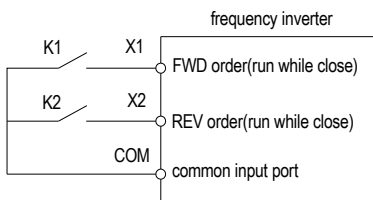

0: 2-line 1

1:2-line 2 Run and direction is separate. FWD terminal X1 is run terminal. FWD terminal X2 state decides direction.

K1	K2	run order
0	0	stop
1	0	FWD
1	1	REV
0	1	stop

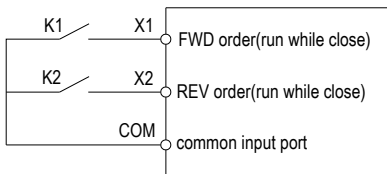

1: 2-line 2

2:3-line 1 Xi is stop run terminal. Run order is decided by FWD terminal X1. Direction is controlled by REV terminal X2. Xi is valid input.

K1	direction control
0	FWD
1	REV

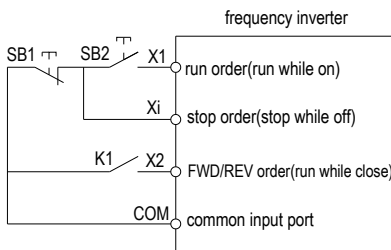

2: 3-line 1

3:3-line 2 Xi is stop run terminal. Run order is decided by FWD terminal X1 or REV terminal X2. Direction is controlled by both terminals.

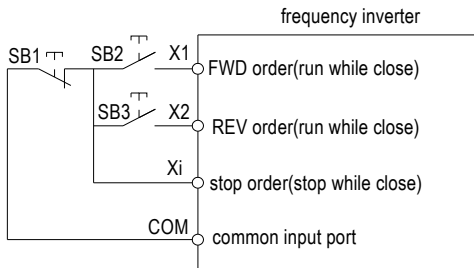

3: 3-line 2

Note: SB1: stop button. SB2: FWD button. SB3: REV button. Xi is set as 3 multi function input terminal [3 line control (Xi)].

F2.13	Terminal act mode	Setting range: 0000-0111	Factory set: 0111
-------	-------------------	--------------------------	-------------------

Only valid while [F0.02] is 1 and [F2.12] is set as 0 or 1.

LED "0" digit: free stop terminal reset mode

0: Reset to original order while invalid

1: Not reset to original order while invalid

LED "00" digit: emergency stop terminal reset mode

0: Reset to original order while invalid

1: Not reset to original order while invalid

LED “000” digit: terminal run mode after fault reset

0: Terminal control to power on directly

1: Terminal control to power on after stop

LED “0000” digit: reserved

Note: 3 channels all can send reset signal to inverter while fault alarm. If it is terminal control mode, inverter can select whether carry out terminal order by these parameters while receiving reset signal of terminal or the other two channels.

F2.14-F2.15	reserved
-------------	----------

F2.16	PUL input min frequency	Setting range: 0.00-50.00kHz	Factory set: 0.00kHz
F2.17	PUL min frequency corresponding setting	Setting range: 0.00-100.00%	Factory set: 0.00%
F2.18	PUL input max frequency	Setting range: 0.00-50.00kHz	Factory set: 50.00kHz
F2.19	PUL max frequency corresponding setting	Setting range: 0.00-100.00%	Factory set: 100.00%
F2.20	PUL filter time	Setting range: 0.00-10.00s	Factory set: 0.10s
F2.21	PUL end frequency	Setting range: 0.000-50.000kHz	Factory set: 0.010kHz

PUL input min frequency: It defines the smallest frequency that pulse input terminal (PUL) can accept. If smaller than this value, inverter will deal as min frequency.

PUL min frequency corresponding setting: It defines the ratio of setting value corresponding to PUL min input frequency.

PUL input max frequency: It defines the max frequency that pulse input terminal (PUL) can accept. If bigger than this value, inverter will deal as max frequency.

PUL max frequency corresponding setting: It defines the ratio of setting value corresponding to PUL max input frequency.

PUL filter time: It is pulse signal filter time to eliminate disturb signal. The longer filter time is, the stronger anti-disturb force is. The shorter filter time is, the weaker anti-disturb force is. But respond speed will be quicker.

PUL end frequency: It is defined as smallest pulse frequency can be identified by PUL. Pulse frequency smaller than this value can not be identified. It will be deal as 0Hz. The smaller this value is, the smaller the pulse frequency identified by PUL is. When PUL frequency is disappears, the time of 0Hz pulse frequency judged by inverter is longer.

F2.22	UP/DW terminal frequency adjust selection	Setting range: 0-2	Factory set: 0
F2.23	UP/DW terminal frequency add/reduce speed	Setting range: 0.01-50.00Hz/s	Factory set: 0.50Hz/s

UP/DW terminal frequency adjust selection

0: Power down save While UP/DW adjustment, it saves frequency records after power down or stop. Inverter continues last UP/DW adjustment while power on.

1: Power down not save, stop save While UP/DW adjustment, it saves frequency records after stop. Inverter continues last UP/DW adjustment while power on. It does not save frequency record after power down. Inverter runs from 0.00Hz.

2: Valid in running, clear zero at stop While UP/DW adjustment, it does not save frequency records after power down or stop. Inverter continues last UP/DW adjustment while power on. Inverter UP/DW adjusts from 0.00Hz next time.

UP/DW terminal frequency increase/reduce speed: While UP/DW adjustment, it modifies change rate of give frequency.

F2.24	Reserved		
-------	----------	--	--

F2.25	Time unit for timer	Setting range: 0-2	Factory set: 0
F2.26	Timer setting	Setting range: 0-65000	Factory set: 0

Time unit for timer

0: Second

1: Minute

2: Hour

Timer setting: It is used for set timing of inverter. Timer start is finished by out timer touch terminal (select by [F2.00-2.07]). Time begins while receiving signal. While time arriving, corresponding output terminal (selected by [F2.29-2.31]) outputs 1s wide pulse signal. If out touch signal always at touching state, corresponding output terminal output one pulse signal every [F2.26] setting time. While touch terminal is invalid, timer keeps records and continues while touch terminal is valid again. Timer clear terminal can clear timer records anytime.

F2.27	Max value of counter	Setting range: 0-65000	Factory set: 1000
F2.28	Setting value of counter	Setting range: 0-65000	Factory set: 500

This parameter stipulates the counting action of the interior counter, clock terminal of the counter is selected by the parameter [F2.00-F2.07].

Max value of counter: When the counter to the reach the count value of exterior clock reach [F2.27] the value of stipulation, in the corresponding output terminal(selected by [F2.29-2.31]) output a width to be equal to exterior clock periodic valid signal.

Setting value of counter: When the counter to the reach the count value of exterior clock reach [F2.28] the value of stipulation, in the corresponding output terminal(selected by [F2.29-2.31]) output valid signal、course the counter clear zero, abolishes this output valid signal.

Counter can be clear zero anytime by multifunction terminal [F2.00-2.07].

The clock periodic requirement of the counter is greater than 10ms; the minimum pulse width is 5ms.

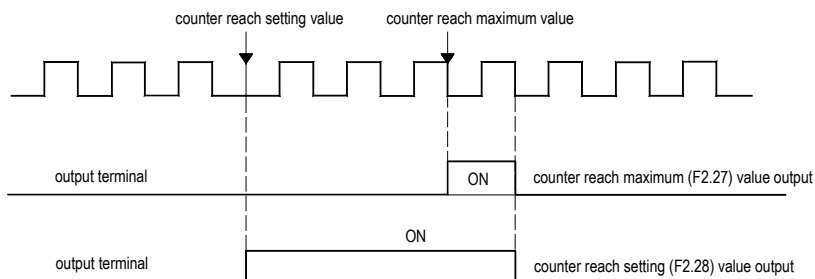

F2.29	Output terminal 1(Y1)	Setting range: 0-29	Factory set: 1
F2.30	Output terminal 2(Y2)		Factory set: 2
F2.31	Relay output terminal(TA-TB-TC)		Factory set: 3

0: No output**1: Running**

2: REV

3: Fault trip alarm 1(alarm while fault self-recover)

4: Fault trip alarm 2(no alarm while fault self-recover)

5: Fault retry

6: Out fault stop

7: Under voltage The frequency converter displays "E.LU1/2" for the voltage is excessively low, output signal.

8: Finish ready for running

9: Output frequency level test 1(FDT1)

10: Output frequency level test 2(FDT2) When the output frequency of frequency converter is over test level [F2.32]/[F2.34] setting, it outputs valid signal after [F2.33]/[F2.35] delay frequency. When output frequency is lower than test level, it outputs invalid signal after delay frequency. Details see [F2.32-F2.35].

11: Frequency arrive Details see [F2.36].

12: Run as 0 speed

13: Upper frequency limit arrive

14: Lowest frequency limit arrive

15: Program running cycle finished One cycle finished, it output 500ms signal.

16: Program running step finished

17:PID feedback over upper limit While PID feedback arrive [Fb.16] and still over limit after [Fb.14] delay time, it output valid signal.

18:PID feedback under lowest limit While PID feedback arrive [Fb.17] and still over limit after [Fb.14] delay time, it output valid signal.

19: PID feedback sensor wire break Details see [Fb.14-Fb.17].

20: Reserved

21: Timer time arrive Details see [F2.25-F2.26].

22: Counter arrive biggest value Details see [F2.27-F2.28].

23: Counter arrive setting Details see [F2.27-F2.28].

24: Energy braking Details see [FA.08].

25: PG feedback break Details see [F5.15-F5.17].

26: Emergency stop

27: Pre alarm output for over load It output valid signal while output current arrive or over [F2.37] and after [F2.38] delay time.

28: Pre alarm output for under load It output valid signal while output current is smaller or equal to [F2.39] and after [F2.40] delay time.

29: Roll diameter arrive output While inverter calculates roll diameter under tension control mode, it outputs valid signal if the current diameter is bigger or equal to the max diameter [F9.12]

Note: Relay output terminal TA-TC on and TB-TC off is valid signal. Y1, Y2 output terminal with low level is combined to (+24V) terminal to output valid signal 24V power.

F2.32	Output frequency level 1(FDT1)	Setting range: 0.00- Max frequency	Factory set: 30.00Hz
F2.33	FDT1 lag	Setting range: 0.00- Max frequency	Factory set: 0.00Hz
F2.34	Output frequency level 2(FDT2)	Setting range: 0.00- Max frequency	Factory set: 50.00Hz
F2.35	FDT2 lag	Setting range: 0.00- Max frequency	Factory set: 0.00Hz

Used to set test level. While output arrives or higher than [F2.32]/[F2.34] setting, FDT 1/2 terminal outputs signal after

[F2.33]/[F2.35] delay frequency. While output arrives or lower than **[F2.32]/[F2.34]** setting, FDT 1/2 terminal stops output signal after **[F2.33]/[F2.35]** delay frequency.

F2.36	Speed arriving checkout range	Setting range: 0.00- Max frequency	Factory set: 0.00Hz
-------	-------------------------------	------------------------------------	---------------------

While output frequency arrive or approach give frequency, output terminal Y1/Y2/TA-TB-TC output valid signal if it is selected as "give frequency arriving". This function can used to adjust test range offset.

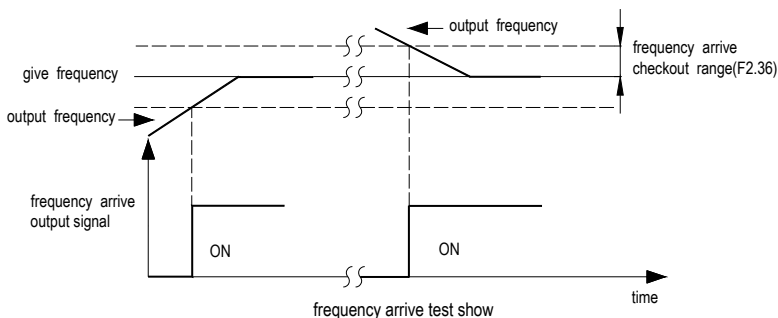

F2.37	Over load pre alarm level	Setting range: 0.0-200.0%	Factory set: 180.0%
F2.38	Over load pre alarm delay	Setting range: 0.0-100.0s	Factory set: 0.5s

While output current is over **[F2.37]** setting continuously, the output terminal outputs valid signal after **[F2.38]** delay frequency. While output current is lower than **[F2.37]** setting, the output terminal outputs invalid signal after **[F2.38]** delay frequency.

F2.39	Under load pre alarm level	Setting range: 0.0-200.0%	Factory set: 30.0%
F2.40	Under load pre alarm delay	Setting range: 0.0-100.0s	Factory set: 0.5s

While output current is equal to or lower than **[F2.39]** setting, the output terminal outputs valid signal after **[F2.40]** delay frequency. While output current is higher than **[F2.39]** setting, the output terminal outputs invalid signal after **[F2.40]** delay frequency. 100.00% corresponding to motor rated current.

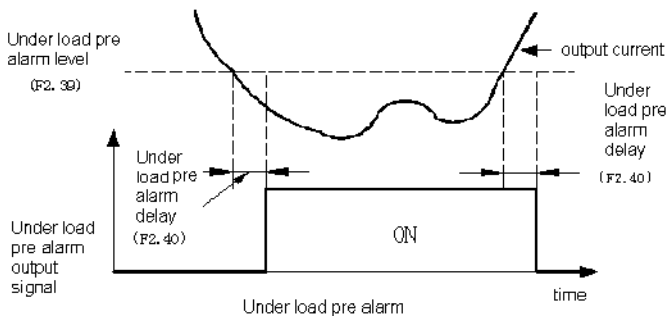

9.4 Analog terminal functions

F3.00	VS1 Lowest limit	Setting range: 0.00-10.00V	Factory set: 0.00V
F3.01	VS1 Lowest limit corresponding setting	Setting range: 0.00-100.00%	Factory set: 0.00%
F3.02	VS1 upper limit	Setting range: 0.00-10.00V	Factory set: 10.00V
F3.03	VS1 upper limit corresponding setting	Setting range: 0.00-100.00%	Factory set: 100.00%
F3.04	VS1 filter time	Setting range: 0.00-10.00s	Factory set: 0.10s

VS1 Lowest limit: It defines signal accepted by analog input terminal (**VS1**), Inverter deal voltage lower than this value as lower limit.

VS1 lower limit corresponding setting: It defines ratio of VS1 lower limit.

VS1 upper limit: It defines signal accepted by analog input terminal (**VS1**), Inverter deal voltage higher than this value as higher limit.

VS1 upper limit corresponding setting: It defines ratio of VS1 upper limit.

VS1 filter time: It is (**VS1**) input analog signal filter time to eliminate disturb signal. The longer filter time is, the stronger anti-disturb force is. The shorter filter time is, the weaker anti-disturb force is. But respond speed will be quicker.

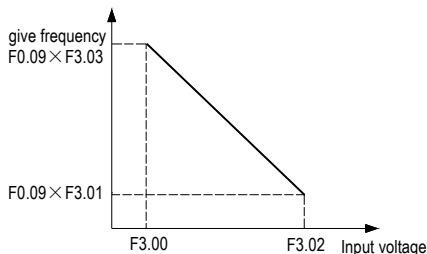
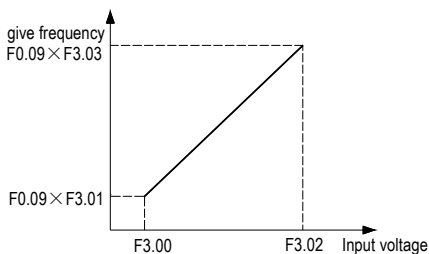

Analog give frequency show

Analog give torque and tension, the relationship:

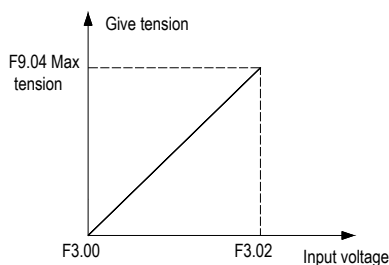
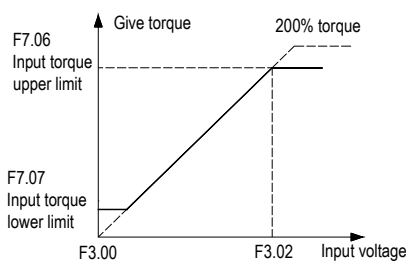

VS1 analog give torque/tension figure

F3.05	VS2 Lowest limit	Setting range: 0.00-10.00V	Factory set: 0.00V
F3.06	VS2 Lowest limit corresponding setting	Setting range: 0.00-100.00%	Factory set: 0.00%
F3.07	VS2 upper limit	Setting range: 0.00-10.00V	Factory set: 10.00V

F3.08	VS2 upper limit corresponding setting	Setting range: 0.00-100.00%	Factory set: 100.00%
F3.09	VS2 filter time	Setting range: 0.00-10.00s	Factory set: 0.10s
F3.10	AS Lowest limit	Setting range: 0.00-20.00mA	Factory set: 4.00mA
F3.11	AS Lowest limit corresponding setting	Setting range: 0.00-100.00%	Factory set: 0.00%
F3.12	AS upper limit	Setting range: 0.00-20.00mA	Factory set: 20.00mA
F3.13	AS upper limit corresponding setting	Setting range: 0.00-100.00%	Factory set: 100.00%
F3.14	AS filter time	Setting range: 0.00-10.00s	Factory set: 0.10s

See VS1 explain.

F3.15-F3.21	Reserved
-------------	----------

F3.22	A01 output selections	Setting range: 0-17	Factory set: 0
F3.23	A02 output selection		Factory set:1

Used for setting inverter monitor corresponding to multifunction terminal **(AO1)**, **(AO2)** output signal.

(AO1) output signal is voltage signal 0-10V.

(AO2) output signal is decided by **[F3.26]**.

Setting	monitor	Function	AO min output	AO max output
0	Set frequency	Corresponding to current give frequency	Min output corresponding to 0.00Hz	Max output corresponding to max frequency
1	running frequency	Corresponding to current output frequency	Min output corresponding to 0.00Hz	Max output corresponding to max frequency
2	Output current	Corresponding to current output current	Min output corresponding to 0.00A	Max output corresponding to 2 times of rated current
3	Input voltage	Corresponding to voltage input voltage	Min output corresponding to 0V	Max output corresponding to 2 times of rated voltage
4	Output voltage	Corresponding to voltage output voltage	Min output corresponding to 0V	Max output corresponding to rated voltage
5	Run speed	Corresponding to machine speed which corresponding to the inverter output	Min output is corresponding to 0RPM	Max output is corresponding to speed which is corresponding to max
6	Set torque	Corresponding to current inverter give torque	Min output corresponding to 0.00% torque	Max output corresponding to 200% torque
7	Output torque	Corresponding to current output torque	Min output corresponding to 0.00% torque	Max output corresponding to 200% torque
8	PID give	Corresponding to current PID give	Min output corresponding to 0.00% PID give	Max output corresponding to 100% PID give
9	PID feedback	Corresponding to current PID feedback	Min output corresponding to 0.00% PID feedback	Max output corresponding to 100% PID feedback
10	Set tension	Corresponding to current max tension setting of	Min output corresponding to 0 power	Max output corresponding to rated output power
11	Bus voltage	Corresponding to current input voltage	Min output corresponding to 0V	Max output corresponding to 2 times rated DC voltage2

12	Current roll diameter	Corresponding to current max diameter setting of	Min output corresponding to 0 meter	Max output corresponding to max diameter
13	VS2 input	Corresponding to current VS2 input	Min output corresponding to VS2 input lowest limit	Max output corresponding to VS2 input upper limit
14	Time per roll	Corresponding to time from empty to full roll	Min output corresponding to 0s	Max output corresponding to time from empty to full roll
15	Reserved			
16	VS1 input	Corresponding to current VS1 input	Min output corresponding to VS1 input lowest limit	Max output corresponding to VS1 input upper limit
17	VS2 input	Corresponding to current VS2 input	Min output corresponding to VS2 input lowest limit	Max output corresponding to VS2 input upper limit
18	AS input	Corresponding to current AS input	Min output corresponding to AS input lowest limit	Max output corresponding to AS input upper limit
19	PUL input	Corresponding to current PUL input	Min output corresponding to PUL input lowest limit	Max output corresponding to PUL input upper limit

F3.24	A01 output gain	Setting range: 25.0-200.0%	Factory set: 100.0%
F3.25	A01 output signal bias	Setting range: -10.0-10.0%	Factory set: 0.0%

A01 output gain: It is used for adjust AO1 terminal output analog.

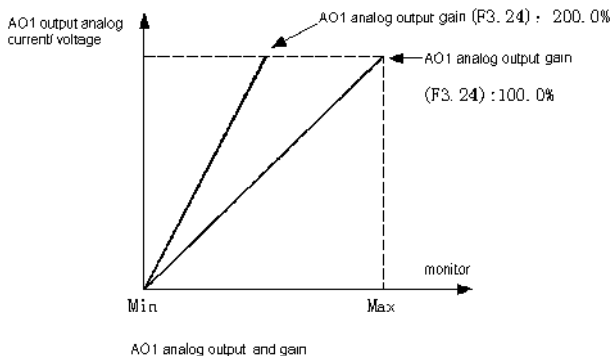

A01 output signal bias: It is used for adjust AO1 terminal 0 point of output signal.

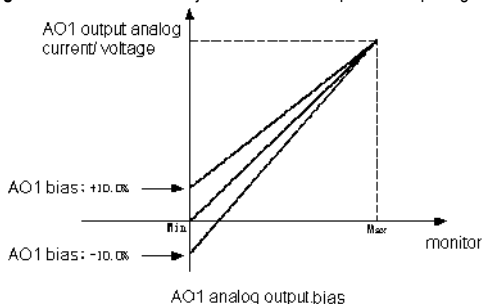

F3.26	AO2 signal selection	Setting range: 0-3	Factory set: 0
-------	----------------------	--------------------	----------------

0: 0-10V

1: 4.00-20.00mA

2: 0.00-20.00mA

3: FM Frequency pulse output lowest limit is decided by [F3.29], upper limit is set by [F3.30].





Note: After output mode is selected by parameter. J1, J2, J3 ON/OFF mode need to select according the following ways:

1. If pulse output, J1 ON, J2, J3 OFF.

2. If 0.00-20.00mA or 4.00-20.00mA output, J2 ON, J1, J3 OFF.

3. If 0-10V output, J1 ON, J2, J3 OFF.

Factory setting is 0-10V output for both hardware and software. If need change, please change both hardware and software.

Switch terminal	Selection position	cutline	function
	J1		0.0-50kHz frequency output
	J2		0-20mA current output 4-20mA current output
	J3		0-10V voltage output

F3.27	A02 output gain	Setting range: 25.0-200.0%	Factory set: 100.0%
F3.28	A02 output signal bias	Setting range: -10.0-10.0%	Factory set: 0.0%

Same as AO1 setting.

F3.29	A02FM frequency output Lowest limit	Setting range: 0.00-50.00kHz	Factory set: 0.20kHz
F3.30	A02FM frequency output upper limit	Setting range: 0.00-50.00kHz	Factory set: 50.00kHz

While AO2 is set as FM frequency pulse output, it is lower limit and upper limit of the signal.

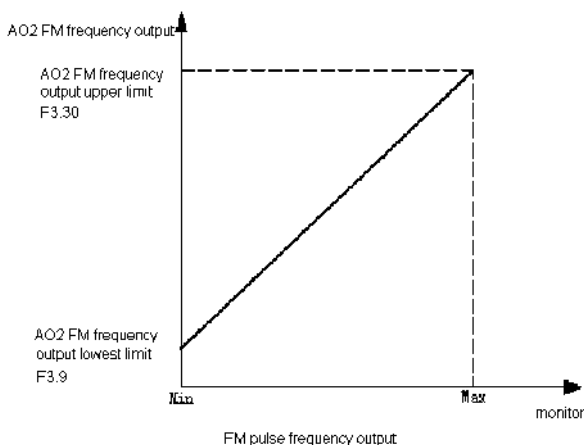

9.5 Keyboard and display parameters

F4.00	Parameter and key lock selections	Setting range: 0-3	Factory set: 0
-------	-----------------------------------	--------------------	----------------

0: Unlock Parameter and keyboard lock function invalid.

1: Parameter lock Lock all function parameter settings, can not modify (except the F0.08). Can not enter into the parameter setting. All buttons in the keypad are unlocked.

2: Parameter and key lock (except FWD/STOP/JOG) Lock all parameter settings, can not modify. And lock all keys on keyboard except FWD/STOP/JOG.

3: All parameter and key lock Lock all parameter settings, can not modify. And lock all keys on keyboard except PRG.

Note:

- 2 lines keypad unlock method: Press "PRG" and 1st line show "CodE". And use the "UP"- "DOWN" key to move to 2nd line, then enter password (F4.01-user password) and press "SET".
- Single line keypad unlock method: Press "PRG" and show "CodE". Press "SET" then enter password (F4.01-user password) and press "SET" again and will be clear!
- User password is a parameter which purpose is to protect the inverter from tampering at will. In order to avoid bring inconvenience, please keep it confidential!

F4.01	User password	Setting range: 0-9999	Factory set: 0
-------	---------------	-----------------------	----------------

It used to set user password. While [F4.00] is (not 0) lock state, need input this password to unlock. Factory set is 0.

F4.02	REV/JOG selections	Setting range: 0-1	Factory set: 0
-------	--------------------	--------------------	----------------

0: REV While keyboard control, press this button, inverter reverse run. Key REV/JOG not light.

1: JOG While keyboard control, press this button, inverter JOG. Key REV/JOG light.

F4.03	STOP key function range	Setting range: 0000-0011	Factory set: 0000
-------	-------------------------	--------------------------	-------------------

LED "0" digit: terminal control

0: invalid to terminal order While terminal given signal, STOP key can not control to stop.

1: **valid to terminal order** While terminal given signal, STOP key can control to stop.

LED“00”digit: **communication control**

0: **invalid to communication order** While terminal given signal, STOP key can not control to stop.

1: **valid to communication order** While terminal given signal, STOP key can control to stop.

LED “000” digit: **reserved**

LED “0000” digit: **reserved**

Note: While valid to terminal order or communication order, inverter is in stop lock state after press STOP key. If inverter needs to restart, stop order needs to be given by selected order channel to unlock stop state firstly.

F4.04	UP/DOWN key modification selections	Setting range: 0000-0014	Factory set: 0011
-------	-------------------------------------	--------------------------	-------------------

LED “0” digit: **keyboard UN/DOWN key modify selection**

0: **Invalid** UP/DOWN key can not modify parameters.

1: **Modify frequency setting by key board numbers (F0.08)** UP/DOWN key can modify parameters **[F0.08]**.

2: **Reserved**

3: **Modify PID give setting by key board numbers (Fb.01)** UP/DOWN key can modify parameters **[Fb.01]**.

4: **Reserved**

LED “00” digit: **keyboard UN/DOWN key store selection**

0: No save after power down

1: Save after power down

It is used to select whether save the parameter modified by UP/DOWN key while power cut.

LED “000” digit: **reserved**

LED “0000” digit: **reserved**

F4.05	Function parameter copy	Setting range: 0-2	Factory set: 0
-------	-------------------------	--------------------	----------------

0: No operation

1: Send machine parameters to keyboard and save

2: Send parameters saved by keyboard to machine

F4.06	Reserved		
-------	----------	--	--

F4.07	Keyboard potentiometer lowest limit	Setting range: 0.00-5.00V	Factory set: 0.50V
F4.08	Keyboard potentiometer lowest limit corresponding setting	Setting range: 0.00-100.00%	Factory set: 0.00%
F4.09	Keyboard potentiometer upper limit	Setting range: 0.00-5.00V	Factory set: 4.50V
F4.10	Keyboard potentiometer upper limit corresponding setting	Setting range: 0.00-100.00%	Factory set: 100.00%

Keyboard potentiometer lowest limit: It defines the lower limit of the signal given by potenmeter. Inverter treat the voltage lower than this value as the lower limit signal.

Keyboard potentiometer lowest limit corresponding setting: It sets ratio of keyboard potentiometer lower limit.

Keyboard potentiometer upper limit: It defines the upper limit of the signal given by potenmeter. Inverter treat the voltage higher than this value as the lower limit signal.

Keyboard potentiometer upper limit corresponding setting: It set ratio of keyboard potentiometer upper limit.

F4.11	Upper LED display content while run	Setting range: 0000-FFFF	Factory set: 3210
F4.12	Upper LED display content while stop	Setting range: 0000-FFFF	Factory set: 3210

Upper LED display content while run: Set monitor content showed in the upper line of LED while running. The content can be modified by "SET" key while running. Not save modification while power cut. Default to display LED "0" digit setting after power on.

Upper LED display content while stop: Set monitor content showed in the upper line of LED while stop. The content can be modified by "SET" key while stop. Not save modification while power cut. Default to display LED "0" digit setting after power on.

LED "0" digit to "0000" digit setting

0: Given frequency 1: Output frequency 2: Output current 3: Input voltage
 4: Output voltage 5: Machine speed 6: Set torque 7: Output torque
 8: PID given value 9: PID feedback value A: Output power B: Bus voltage
 C: Module temperature 1 D: Module temperature 2 E: ON/OFF state of input terminal X
 F: ON/OFF state of input terminal Y

F4.13	Lower LED display content while run	Setting range: 0000-FFFF	Factory set: 3210
F4.14	Lowest LED display content while stop	Setting range: 0000-FFFF	Factory set: 3210

Only valid for keyboard with 2 line LED. Details refer to [F4.11-F4.12].

F4.15	Rotate speed display coefficient	Setting range: 0.0-5000.0%	Factory set: 0000
-------	----------------------------------	----------------------------	-------------------

It sets the display coefficient of keyboard monitor item "machine speed". 100% is corresponding to motor rated speed.

F4.16	LCD language	Setting range: 0000-1111	Factory set: 0000
-------	--------------	--------------------------	-------------------

LED "0" digit: LED display language

0: Chinese
 1: English

LED "00" digit: output frequency selection

0: Aim frequency
 1: Actual frequency

LED "000" digit: machine speed display selection

0: Actual speed
 1: Aim speed

LED "0000" digit: reserved

9.6 Motor parameters

F5.00	Reserved		
-------	----------	--	--

F5.01	Motor rate	Setting range: 2-48	Factory set: 4
-------	------------	---------------------	----------------

Set it according to nameplate.

F5.02	Motor rated power	Setting range: 0.4-1000.0kW	Factory set: Accord model
-------	-------------------	-----------------------------	---------------------------

Set it according to nameplate based on unit of 0.1kw. While motor rated power setting is changed, inverter will automatic adjust [F5.03-F5.11] to default. If self-study, [F5.07-F5.11] will automatic change according to the result of self study. If need high accuracy control, It must self study after right [F5.01-F5.06] setting.

F5.03	Motor rated frequency	Setting range: 0.01Hz-max frequency	Factory set: Accord model
-------	-----------------------	-------------------------------------	---------------------------

Set it according to nameplate.

F5.04	Motor rated speed	Setting range: 0-65000rpm	Factory set: Accord model
-------	-------------------	---------------------------	---------------------------

Set it according to nameplate.

F5.05	Motor rated voltage	Setting range: 0-1500V	Factory set: Accord model
-------	---------------------	------------------------	---------------------------

Set it according to nameplate.

F5.06	Motor rated current	Setting range: 0.1-2000.0A	Factory set: Accord model
-------	---------------------	----------------------------	---------------------------

Set it according to nameplate.

F5.07	Motor no-load current	Setting range: 0.01-650.00A	Factory set: Accord model
-------	-----------------------	-----------------------------	---------------------------

It set automatic while self study.

F5.08	Motor stator resistance	Setting range: 0.001-65.000	Factory set: Accord model
-------	-------------------------	-----------------------------	---------------------------

It set automatic while self study.

F5.09	Motor rotor resistance	Setting range: 0.001-65.000	Factory set: Accord model
-------	------------------------	-----------------------------	---------------------------

It set automatic while self study.

F5.10	Motor stator&rotor inductance	Setting range: 0.1-6500.0mH	Factory set: Accord model
-------	-------------------------------	-----------------------------	---------------------------

It set automatic while self study.

F5.11	Motor stator&rotor mutual inductance	Setting range: 0.1-6500.0mH	Factory set: Accord model
-------	--------------------------------------	-----------------------------	---------------------------

It set automatic while self study.

F5.12	Parameters self-adjustment selections	Setting range: 0-2	Factory set: 0
-------	---------------------------------------	--------------------	----------------

0: No operation Set as default without self study.

1: Rotary type self-study Before self adjustment, [F5.01-F5.06] of asynchronous motor which is controlled must be set as right value. While self adjustment, firstly, asynchronous motor at static state, it automatic detects motor stator resistance, motor rotor resistance, motor stator&rotor inductance. Then the asynchronous motor at rotate state, it automatic detects motor no-load current, motor stator&rotor mutual inductance. All results will be auto written in [F5.08], [F5.09], [F5.10] and [F5.07], [F5.11] and renewed while adjustment is over. After parameter setting, press FWD key to start self study, keyboard LED display "t-01". Motor automatic stop while self adjustment is over. Inverter reback to standby state.

2: Resting type self-study Before self adjustment, [F5.01-F5.06] of motor which is controlled must be set as right value. While self adjustment, motor at static state, it automatic detects motor stator resistance, motor rotor resistance, motor stator&rotor inductance. All results will be auto written in [F5.08], [F5.09], [F5.10] and renewed while adjustment is over. After parameter setting, press FWD key to start self study, keyboard LED display "t-02". FWD indicator is off while self adjustment is over. Inverter reback to standby state.

Note: [F5.12] is automatic set as 0 after self adjustment.

Attention: 1. Before set ting [F5.12] as 1 –self study, unload the motor firstly.

2. In some occasions (such as can not unload), if it can not self study or it is not high control accuracy required, static self study or no self study is ok. If no self study, please do set right parameters [F5.01-F5.06]

3. If user know the right parameter. User can set [F5.01-F5.11] directly.

4. Ensure stop state before startting self study, otherwise, self study can not be normal.

5. While [F5.12] is 1, if there is over voltage or over current in self study process, ACC/DEC time [F0.14, F0.15] can be prolonged.

6. If static self study is not successful, alarm E.tE1 fault. If rotary self study is not successful, alarm E.tE2 fault.

F5.13-F5.14	Reserved
-------------	----------

F5.15	PG selection	Setting range: 0000-1111	Factory set: 0001
F5.16	PG pulse per loop	Setting range: 0-60000	Factory set: 1024
F5.17	PG line-break inspection time	Setting range: 0.100-60.000s	Factory set: 2.000s

PG selection:

LED "0" digit: Input phase

0: 1-phase input Only feedback one of A and B and inspect motor speed. Not identify direction.

1: 2-phase input Feedback both A and B. Inspect both speed and direction.

LED "00" digit: input phase adjustment

While encoder A/B phase is converse, it can be adjusted by this parameter. No need to change the wire. Only valid while both phase are valid.

0: same direction Sensor phase is the same as motor phase, no need adjust.

1: reverse direction Sensor phase is reverse to motor phase, need adjust.

LED "000" digit:

0: break inspection OFF No line-break inspection.

1: break inspection ON While feedback signal of sensor disappears and after [F5.17] delay time, still no feedback signal is received. Inverter will alarm for PG line-break fault and stop output. Motor free stop.

LED "0000" digit: PG feedback channel

0: PG port

1: PUL port

Note: Under closed loop mode, while feedback signal is 2 phase input and PG card feedback direction is reverse to motor output direction. Inverter can not run normally. Please adjust [F5.15] LED "00" digit setting.

PG pulse per loop: Set according sensor specification.

PG line-cut inspection time: Set delay time for ensure sensor line break while sensor line-break inspection is valid.

9.7 VC control parameter

F6.00	ASR proportional gain 1	Setting range: 0.00-1.00	Factory set: Accord model
F6.01	ASR integral time 1	Setting range: 0.01-10.00s	Factory set: Accord model
F6.02	ASR differential coefficient time 1	Setting range: 0.0-100.0	Factory set: 0.0
F6.03	ASR filter time1	Setting range: 0.000-0.100s	Factory set: 0.005s
F6.04	ASR switch frequency 1	Setting range: 0.00-50.00Hz	Factory set: 5.00Hz
F6.05	ASR proportional gain 2	Setting range: 0.00-1.00	Factory set: Accord model
F6.06	ASR integral time 2	Setting range: 0.01-10.00s	Factory set: Accord model
F6.07	ASR differential coefficient time 2	Setting range: 0.0-100.0s	Factory set: 0.0s
F6.08	ASR filter time 2	Setting range: 0.000-0.100s	Factory set: 0.001s
F6.09	ASR switch frequency 2	Setting range: 0.00-50.00Hz	Factory set: 10.00Hz

[F6.00-F6.09] is only valid under VC control and PG V/F control. It changes speed response by set proportional gain P and integral time of speed adjustor.

ASR proportional gain and ASR integral time adjustment: System response will be quicker by increase proportional gain. But if proportional gain is too big, there is surge easily. System response will be quicker by decreasing integral time. But if integral time is too short, there is surge easily. Usually, adjust proportional gain firstly, then adjust integral time.

Note: If ASR proportional gain is too big and ASR integral time is too small, over voltage maybe caused while system start to high speed quickly (without extra braking resistance or braking unit). It is caused by erborn energy feedback and can be avoided by adjust ASR proportional gain bigger and ASR integral time smaller.

ASR proportional gain and ASR integral time adjustment at high/low speed: Set ASRswitch frequency [F6.04] and [F6.09] while it has quick response requirement for load at high/low speed.

Usually increase proportional gain and decrease integral time to improve response at low frequency running. Usually adjust as this: Set right [F6.04] and [F6.09]. The first group of ASR parameter is valid while output frequency is under switch frequency 1 [F6.04]. The second group of ASR parameter is valid while output frequency is between switch frequency 1 [F6.04] and switch frequency 2 [F6.09]. Parameter linearly transits from switch frequency 1 [F6.04] to switch frequency 2 [F6.09] prorata. Adjust ASR proportional gain 1 [F6.00] and ASR integral time 1 [F6.01] at low speed to ensure no surge and good response. Adjust ASR proportional gain 2 [F6.05] and ASR integral time 2 [F6.06] at high speed to ensure no surge and good response.

Usually, ASR differential coefficient time is not need to set. It is used to restrain suddent speed change. If it is too big, surge comes easily.

F6.10	VC control slip coefficient	Setting range: 10-250%	Factory set: 100%
-------	-----------------------------	------------------------	-------------------

Used in occocation need quick response and high speed accuracy. Adjust this parameter properly, the system response can be improved and stable speed error can be eliminated.

F6.11	Max output torque	Setting range: 20.0-200.0%	Factory set: 180.0%
-------	-------------------	----------------------------	---------------------

100.00% is corresponding to rated current.

F6.12	Constant power area torque compensation start frequency	Setting range: 100.0-500.0%	Factory set:120.0%
F6.13	Constant power area torque compensation coefficient	Setting range: 0-100%	Factory set: 30%

Constant power area torque compensation start frequency: Set start frequency of torque compensation in constant power area under VC control. 100.00% is corresponding to motor rated frequency.

Constant power area torque compensation coefficient: Set coefficient of torque compensation in constant power area. The coefficient is bigger, the compensation is bigger. While this function is on, it effectively helps to improve load capability at motor weak magnetic area.

F6.14	Constant power area limit start frequency	Setting range: 100.0%-500.0%	Factory set: 200.0%
F6.15	Constant power area limit value	Setting range: 50-200%	Factory set: 120%

Constant power area limit start frequency: Set to switch to start frequency of torque limitation in constant power area under VC control. 100.00% is corresponding to motor rated frequency.

Constant power area limit value: Set limitation of torque in constant power area. It can effectively anti motor stall at weak magnetic area by reduce this limitation properly.

F6.16	DEC over-excitation selection	Setting range: 0-1	Factory set: 0
F6.17	DEC over-excitation current setting	Setting range: 50.0-200.0%	Factory set: 115.0%
F6.18	DEC over-excitation gain	Setting range: 0.00-1.50	Factory set: Accord model

DEC over-excitation selection: 0: off; 1: on

DEC over-excitation current setting: It sets the excitation current while DEC over-excitation.

DEC over-excitation current= motor rated current * DEC over-excitation current setting

DEC over-excitation gain: It is used to adjust the excitation magnetic field building speed. This function can keep stable excitation flux. So that frequency inverter can quickly stop. The magnetic field need time to build up. If the gain is too big, it is easy to cause over current (E.OC).

Note: 1,It is easy cause over heat if use DEC over-excitation frequently. So we suggest to add right brake resistor if need quick stop/start frequently,2, Set right DEC time to avoid E.OU2 (over voltage). 3, If input run order while DEC over-excitation, it will ACC to setting frequency again.

9.8 Torque control parameter

F7.00	Torque give source selection	Setting range: 0000-0577	Factory set: 0000
-------	------------------------------	--------------------------	-------------------

It used to select channel for torque given while torque control.

LED "0" digit: Main channel selection

0: Keyboard number given torque [F7.01] keyboard number give frequency give and modify main torque

1: Keyboard potentiometer given

2: VS1

3: VS2

4: AS

5: PUL

6: RS485 communication give

7: Tension control give

LED "00" digit: Second channel selection

0: Keyboard number given torque [F7.01] keyboard number give frequency give and modify main torque

1: Keyboard potentiometer given

2: VS1

3: VS2

4: AS

5: PUL

6: RS485 communication gives

7: Tension control gives

LED "000" digit: Main channel add second channel mode

0: MainX [F7.02] Main channel is valid, Main channel giving value is main channel giving value multiply torque give main channel gain [F7.02]

1: Second× [F7.03] Second channel is valid, Second channel giving value is second channel giving value multiply torque give second channel gain [F7.03]

2: MainX [F7.02] + SecondX [F7.03] The result of main channel giving value multiply torque give main channel gain [F7.02] add the result of second channel giving value multiply torque give second channel gain [F7.03]. Then sum is the output torque of the inverter.

3: Main X [F7.02] — Second X [F7.03] The result of main channel giving value multiply torque give main channel gain [F7.02] minus the result of second channel giving value multiply torque give second channel gain [F7.03]. Then the result is the output torque of the inverter.

4: MAX{main X [F7.02],second X [F7.03]} The bigger one of the result of main channel giving value multiply torque give main channel gain [F7.02] and the result of second channel giving value multiply torque give second channel gain [F7.03] is the output torque of the inverter.

5: MIN {main X [F7.02],second X [F7.03]} The smaller one of the result of main channel giving value multiply torque give main channel gain [F7.02] and the result of second channel giving value multiply torque give second channel gain [F7.03] is the output torque of the inverter.

LED "0000" digit: Reserved

F7.01	Keyboard number give torque	Setting range: 0%-200.0%	Factory set: 100.0%
-------	-----------------------------	--------------------------	---------------------

Set torque given value by keyboard. While [F4.04] LED "0" digit is 2, the parameter can be modified by UP/DW key. Whether save modification is decided by [F4.04] LED "00" digit setting. It can adjust torque given value.

F7.02	Main torque give channel gain	Setting range:0-500.0%	Factory set: 100.0%
F7.03	Second torque give channel gain	Setting range:0-500.0%	Factory set: 100.0%

Main torque give channel gain: It is used to magnify or reduce the main channel torque by ratio.

Second torque give channel gain: It is used to magnify or reduce the second channel torque by ratio.

F7.04	Reserved		
-------	----------	--	--

F7.05	Output torque upper limit set selection	Setting range: 0-6	Factory set: 0
-------	---	--------------------	----------------

Output torque upper limit set selection: Select the giving source of the output torque upper limit.

0: Keyboard No give Output torque upper limit set by [F7.06]; Max setting is smaller or equal to [F7.06], Smallest setting is bigger or equal to [F7.07].

1: Keyboard potentiometer gives

2:VS1 give

3: VS2 give

4: AS give

5: PUL give

6: RS485 give

F7.06	Output torque upper limit	Setting range: Lowest limit of output torque - max output torque	Factory set:120.0%
F7.07	Output torque lowest limit	Setting range: 0.0- upper limit of output torque	Factory set:1.0%

F7.08- F7.09	Reserved		
--------------	----------	--	--

F7.10	Zero speed value	Setting range: 0.00~50.00Hz	Factory set:1.00Hz
F7.11	Zero speed torque gain	Setting range: 0.0~500.0%	Factory set:100.0%

Zero speed value: It is recognized as zero speed working state while frequency inverter frequency is lower than [F7.10]

Zero speed torque gain: It is output torque while frequency inverter is zero speed working. It is mainly used for keeping certain tension at zero speed. This value take give torque as base, totally corresponding to torque give value.

Calculation formula:

$$\text{Torque at zero speed} = \text{give torque} * \text{zero speed torque gain}$$

Use this value to set output torque at zero speed and running state separately to meet requirement

F7.12	Torque ACC time	Setting range: 0.00-100.00s	Factory set: 0.5s
F7.13	Torque DEC time	Setting range: 0.00-100.00s	Factory set: 0.5s

Torque ACC time: Time of output torque from 0.0% up to 200.0% while torque control.

Torque DEC time: Time of output torque from 200.0% down to 0.0% while torque control.

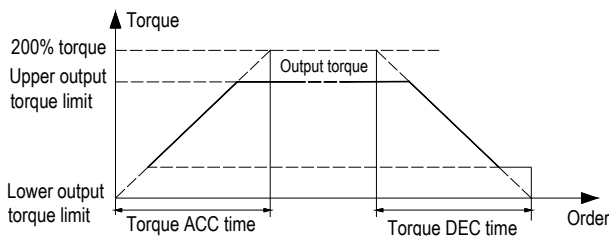

Upper/lower torque limit and torque ACC/DEC time relationship

F7.14	FWD/REV dead time	Setting range: 0.00-650.00s	Factory set: 0.00s
-------	-------------------	-----------------------------	--------------------

Waiting time at 0.0% torque while change torque direction.

F7.15	Static friction compensation	Setting range: 0-200.0%	Factory set: 0
F7.16	Static friction cutoff frequency	Setting range: 0.00-50.00Hz	Factory set: 10.00Hz

Static friction compensation: It compensates the static friction while system starts up.

Static friction cutoff frequency: While unwinding frequency is bigger than this value. The static friction compensation is cancelled.

F7.17	Sliding friction compensation	Setting range: 0-200.0%	Factory set: 0
-------	-------------------------------	-------------------------	----------------

Sliding friction compensation: It compensates the sliding friction of the whole system in running. Increase this value to improve tension while material tension is not enough.

F7.18	Moment of inertia compensation	Setting range:0-200.0%	Factory set: 0
F7.19	Moment of inertia compensation input ACC time	Setting range:0.0-6000.0s	Factory set: 0
F7.20	Moment of inertia compensation input DEC time	Setting range:0.0-6000.0s	Factory set: 0

Moment of inertia compensation: This value is used to compensate the moment of inertia of rotating bodies, such as motor, transmission system, scrolls and others in acceleration. During deceleration, it compensates reverse torque to the system to ensure the tension balance in slow down process. The moment of inertia is direct ratio to the rotating body quality and rotation acceleration. Moment of inertia is greater when the system acceleration is greater. It is smaller when the system acceleration is smaller. In winding process, if material tension is not enough in acceleration, then increase this value, otherwise decrease the value.

Moment of inertia compensation input ACC time: Moment of inertia compensates time for ACC from 0.0% to 200.0%

Moment of inertia compensation input DEC time: Moment of inertia compensates time for DEC from 200.0% to 0.0%

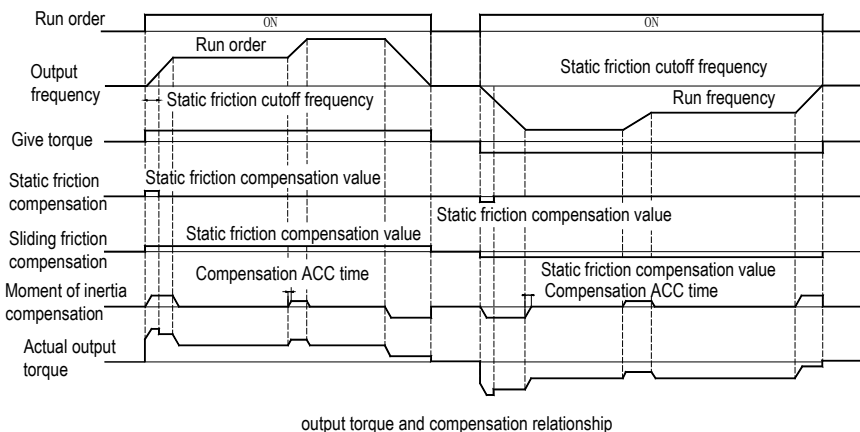

F7.21	Zero-speed torque keep selection in the torque control mode	Setting range:0000-0011	Factory set:0010
-------	---	-------------------------	------------------

LED "0" digit: Zero-speed torque keep set channel

0: Torque setting Motor output torque is setting torque while inverter running frequency is 0Hz

1: F1.27 setting Motor output torque is setting torque while inverter running frequency is [F1.27]

LED "00" digit: Zero-speed torque keeps time set

0: Zero-speed continue valid Inverter continually output torque at zero frequency and stop zero frequency torque only at stop or running frequency is bigger than 0Hz

1: Zero-speed valid in F1.28 time Inverter output torque time is controlled by [F1.28]

LED "000" digit: Reserved

LED "00" digit: Reserved

Note: This parameter is valid only under torque control or tension open loop control under torque control mode. Under speed mode, zero speed torque keep function is decided by [F1.27]-[F1.28]

F7.22	Zero speed slip frequency settings	Setting range:0.0-5.00Hz	Factory set:1.00
-------	------------------------------------	--------------------------	------------------

Zero speed slip frequency settings: Right setting can keep stable tension while motor is zero speed (stall)

While give torque is fixed, if this value increases, zero speed tension will increase. It will be more stable. If this value decreases, zero speed tension will decrease. It will be more not stable.

F7.23	Torque control upper frequency limit selection	Setting range:0000-2660	Factory set: 0000
-------	--	-------------------------	-------------------

Torque control upper frequency limit selective: Torque control takes the motor torque as control aim. The frequency or speed increase or decrease is decided by the difference between the set torque and the load torque. However, in order to prevent stall, the output frequency limit is very necessary. Under torque mode, the inverter can be achieved to set torque and frequency limits separately. Torque is set by the torque give channel. Frequency limits set by the frequency give channel, but also limited by the upper frequency limit. This parameter is used to select the upper frequency limit give source under torque control.

Upper frequency limit selection under torque control	0: FWD/REV set by[F0.10]	1: FWD set by LED "00" digit REV set by LED "000" digit
Give frequency limit range		
Feature	FWD/REV upper/lower limit all setby F0.10	Set FWD upper/lower limit separately

LED "0" digit: Torque control upper frequency limit selection

0: FWD/REV set by [F0.11]. Same as speed control

1: FWD set by LED "00"digit; REV set by LED "000"digit. Used where need set FWD upper/lower limit separately

LED "00" digit: FWD upper frequency limit set

0: Torque control FWD upper frequency limit No set (F7.24) + max frequency*torque control FWD upper frequency limit bias.

1: Keyboard pot give +max frequency*torque control FWD upper frequency limit bias.

2:VS1 give +max frequency*torque control FWD upper frequency limit bias.

3:VS2 give +max frequency*torque control FWD upper frequency limit bias.

4: AS give +max frequency*torque control FWD upper frequency limit bias.

5: PUL give +max frequency*torque control FWD upper frequency limit bias.

6:RS485 give +max frequency*torque control FWD upper frequency limit bias.

LED "000" digit: REV upper frequency limit set

0: Torque control REV upper frequency limit No set (F7.26) + max frequency*torque control REV upper frequency limit bias.

1: Keyboard pot give +max frequency*torque control REV upper frequency limit bias.

2:VS1 give +max frequency*torque control REV upper frequency limit bias.

3:VS2 give +max frequency*torque control REV upper frequency limit bias.

4: AS give +max frequency*torque control REV upper frequency limit bias.

5: PUL give +max frequency*torque control REV upper frequency limit bias.

6:RS485 give +max frequency*torque control REV upper frequency limit bias.

F7.24	Torque control FWD upper frequency limit No set	Setting range: Lower limit-Max output frequency	Factory set: 50.00
F7.25	Torque control FWD upper frequency limit bias	Setting range: 0.0-20.0%	Factory set:0.0

Torque control FWD upper frequency limit No set: It sets FWD speed limit under torque control.

Torque control FWD upper frequency limit bias: It adjusts FWD speed limit. After bias, FWD frequency under torque control is.

FWD frequency under torque control= Torque control FWD upper frequency limit No set+(max frequency*

Torque control FWD upper frequency limit bias)

F7.26	Torque control REV upper frequency limit No set	Setting range: Lower limit-Max output frequency	Factory set: 50.00
F7.27	Torque control REV upper frequency limit bias	Setting range: 0.0-20.0%	Factory set:0.0

Torque control REV upper frequency limit No set: It sets REV speed limit under torque control.

Torque control REV upper frequency limit bias: It adjusts REV speed limit. After bias, FWD frequency under torque control is.

REV frequency under torque control= Torque control REV upper frequency limit No set+(max frequency*

Torque control REV upper frequency limit bias)

F7.28	Upper frequency limit under small torque	Setting range: 0.00-50.00Hz	Factory set: 3.00Hz
-------	--	-----------------------------	---------------------

Upper frequency limit under small torque: It sets max output frequency under small torque output to keep stable speed.

F7.29	Small torque value threshold	Setting range: 0-200.0% (0:This function off)	Factory set: 0.0%
-------	------------------------------	---	-------------------

Small torque value threshold: While give torque is smaller than this value, the inverter output frequency upper limit is [F7.28]. It is main function is to keep stable speed under certain small torque.

While it is "0",inverter close this function and stop output. The motor is in free state.

F7.30	Magnetic powder brake current give channel	Setting range: 0000-4450	Factory set: 0010H
-------	--	--------------------------	--------------------

LED "0" digit: main channel selection

0: Keyboard give [F7.31] keyboard No set frequency give or modify

1: Keyboard pot give or modify

2: VS1 give or modify

3: VS2 give or modify

4: AS give or modify

LED "00" digit: Second channel selection

0: Keyboard give [F7.31] keyboard No set frequency give or modify

1: Keyboard pot give or modify

2: VS1 give or modify

3: VS2 give or modify

4: AS give or modify

LED "000" digit: Main channel combines second channel

0: Main× [F7.32]

1: Second×[F7.33]

2: Main×[F7.32]+second×[F7.33]

3: Main×[F7.32]—second×[F7.33]

4: MAX {Main× [F7.32], second×[F7.33]}

5: MIN {Main× [F7.32], second×[F7.33]}

LED "0000" digit: Reserved

Note: 1. Consider the radiator carefully while using this function.

2. Magnetic powder brake function has priority. It switches to magnetic powder brake state while the multi function terminal start magnetic powder brake function is valid.

F7.31	Magnetic powder brake current keyboard No give	Setting range: 0-200.0%	Factory set: 100.0%
-------	--	-------------------------	---------------------

Magnetic powder brake current keyboard No give: when the keyboard setting, it sets the brake torque give the magnetic powder by this parameter. If the parameters [F4.04] LED "0" digit set as "4", the value of the parameter can be modified through the keyboard up / down shortcuts. After modify the parameters, the frequency converter whether to save the modified value is decided by the [F4.04] LED "00"digit. F4. Ten settings of the 04 the LED decision.

F7.32	Magnetic powder brake main channel gain	Setting range: 0-500.0%	Factory set: 100.0%
F7.33	Magnetic powder brake second channel gain	Setting range: 0-500.0%	Factory set: 100.0%

Magnetic powder brake main channel gain: To zoom in or out of the main torque give channel signal of the powder brake. It can adjust the main channel torque by rata.

Magnetic powder brake second channel gain: To zoom in or out of the second torque give channel signal of the powder brake. It can adjust the main channel torque by rata.

9.9 V/F control parameters

F8.00	V/F curve selection	Setting range:0-4	Factory set: 0
-------	---------------------	-------------------	----------------

0 beeline can be selected for general used load. Falling torque curve can be for fan and pump.

0: Beeline

1: User-defined V/F curve Details refer to [F8.01-F8.10].

2: 1.3 power falling torque curve

3: 1.7 power falling torque curve

4: 2.0 power falling torque curve

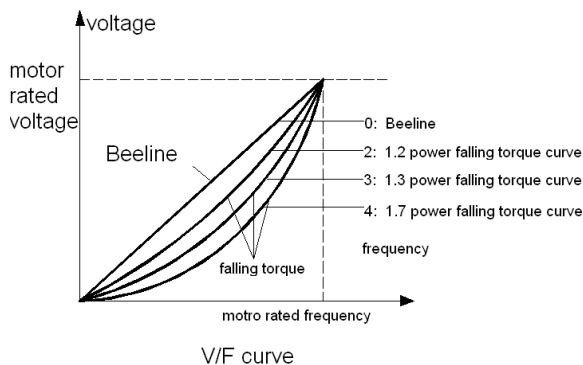

Parameter	Setting	Setting range	Factory set
F8.01	Self-setting voltage V1	Setting range: 0.0-100.0%	Factory set: 3.0%
F8.02	Self-setting frequency F1	Setting range: 0.00-max frequency	Factory set: 1.00Hz
F8.03	Self-setting voltage V2	Setting range: 0.0-100.0%	Factory set: 28.0%
F8.04	Self-setting frequency F2	Setting range: 0.00-max frequency	Factory set: 10.00Hz
F8.05	Self-setting voltage V3	Setting range: 0.0-100.0%	Factory set: 55.0%
F8.06	Self-setting frequency F3	Setting range: 0.00-max frequency	Factory set: 25.00Hz
F8.07	Self-setting voltage V4	Setting range: 0.0-100.0%	Factory set: 78.0%
F8.08	Self-setting frequency F4	Setting range: 0.00-max frequency	Factory set: 37.50Hz
F8.09	Self-setting voltage V5	Setting range: 0.0-100.0%	Factory set: 100.0%
F8.10	Self-setting frequency F5	Setting range: 0.00-max frequency	Factory set: 50.00Hz

Self-setting V/F curve: User sets the 1st/2nd/3rd/4th/5th voltage ratio of V/F curve corresponding to F1/F2/F3/F4/F5 frequency based on rated output voltage 100%. User sets the 1st/2nd/3rd/4th/5th frequency of V/F curve corresponding to V1/V2/V3/V4/V5.

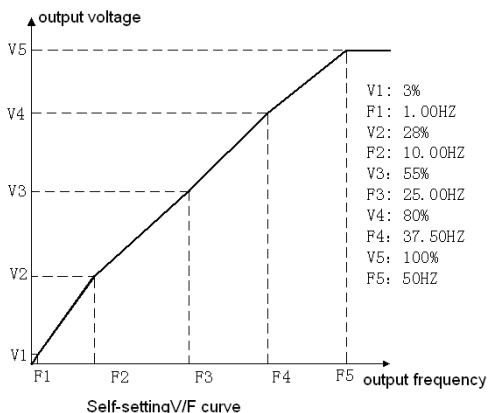

Must meet: $0 \leq F1 \leq F2 \leq F3 \leq F4 \leq F5 \leq \text{max frequency}$; $0 \leq V1 \leq V2 \leq V3 \leq V4 \leq V5 \leq 100.0\%$

V1、V2、V3、V4、V5 is based on motor rated voltage.

F8.11	Output voltage percentage	Setting range: 25-100%	Factory set: 100%
-------	---------------------------	------------------------	-------------------

Output voltage adjustment coefficient adjusts output voltage of inverter to meet different V/F requirement.

F8.12	Torque improve	Setting range: 0.1-30.0%	Factory set: Accord model
F8.13	Torque improve close frequency	Setting range: 0.0-100.0%	Factory set: 20.0%

Torque improve: Improve low frequency torque trait by voltage compensation. Please set it rightly. If too high, motor maybe happens over excitation at low frequency running, over heat while long time, even over current protection or can not start normally.

Note: while [F8.00] is 1, [F8.12] is invalid.

Torque improve close frequency: Set torque improve valid range. While output frequency is over this value, torque improving function stops. 100% is corresponding to motor rated frequency.

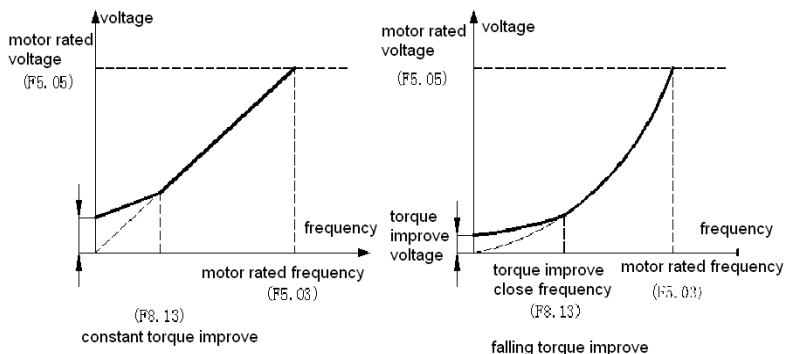

F8.14	V/F slip compensation	Setting range:0.0-200.0%	Factory set:0.0%
-------	-----------------------	--------------------------	------------------

It makes inverter output frequency self adjust within a setting range according motor load change to compensate slip frequency to make motor keep constant speed. It effectively relieves the impact of load change to motor speed.

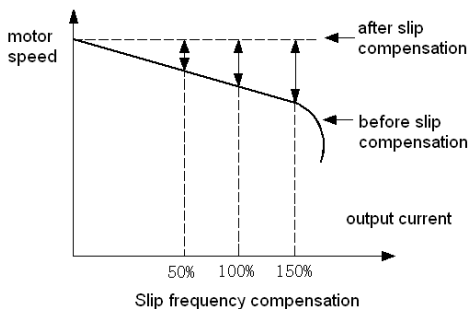

If compensation setting is too big, it maybe causes motor speed over settings.

F8.15	Auto energy save selection	Setting range: 0-1	Factory set: 0
F8.16	Lowest frequency limit of energy save running	Setting range: 0.0-500.0%	Factory set: 25.0%
F8.17	Energy save voltage down time	Setting range: 0.01-50.00s	Factory set: 10.00s
F8.18	Energy save voltage lowest limit	Setting range: 20.0-100.0%	Factory set: 50.0%

Auto energy save selection:

0: no auto energy save

1: auto energy save

Lower frequency limit of energy save running: While output frequency is lower than this value, auto energy save function will close. 100% is corresponding to motor rated frequency.

Energy save voltage down time: It is the time output voltage from rated voltage to 0V while meet auto energy save conditions.

Energy save voltage lowest limit: Set lowest limitation of voltage while energy save running. 100% is corresponding to motor rated frequency.

F8.19	ASR(VF) proportion gain1	Setting range:0.0-100.00	Factory set: 1.00
F8.20	ASR(VF) integral time 1	Setting range:0.01-10.00s	Factory set: 0.50s
F8.21	ASR(VF) filter time1	Setting range:0.000-10.000s	Factory set: 0.005s
F8.22	ASR(VF) switch frequency 1	Setting range:0.00-50.00Hz	Factory set: 5.00Hz
F8.23	ASR(VF) proportion gain 2	Setting range:0.0-100.00	Factory set: 1.00
F8.24	ASR(VF) integral time 2	Setting range:0.01-10.00s	Factory set: 0.50s
F8.25	ASR(VF) filter time 2	Setting range:0.000-10.000s	Factory set: 0.100s
F8.26	ASR(VF) switch frequency 2	Setting range:0.00-50.00Hz	Factory set: 10.00Hz

[F8.19-F8.26] is valid under V/F with PG mode. It changes the speed response features by setting proportion gain P and integral time I of the speed adjuster.

ASR (VF) proportion gain: Make inverter respond quicker to load by adjust proportion gain bigger. But it is easy to cause vibration while proportion gain is too big. Make inverter respond slower to load by adjust proportion gain smaller. It is easy to reduce vibration while proportion gain is small.

ASR (VF) integral time: Respond to sudden changed load will be slower while integral time is long. But it is valid to reduce vibration. General speaking, the proportion gain is adjusted firstly (as big as possible based on no system vibration). Then adjust integral time to make system has quick respond without vibration.

ASR (VF) filter time: It is easy to be disturbed while PG card sampling. So it needs to filter.

ASR proportion gain, integral time adjustment at high/low speed: If system needs quick respond both at high and low speed, it can set ASR(VF)switch frequency [F8.22] and [F8.26] .

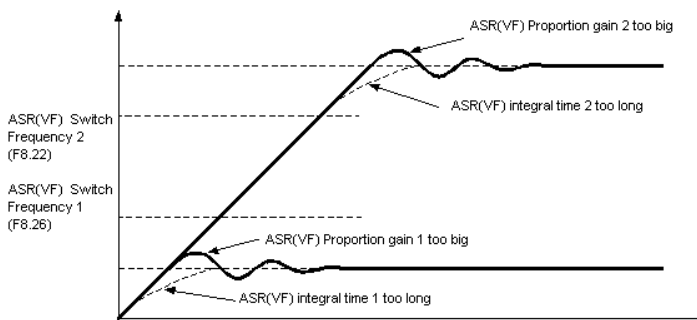

Relationship between Proportion gain and Integral time under PG V/F control

Note: If proportion gain is too big and integral time is too short, the system may meets voltage fault after start to high speed at short time (no optional resistance and break unit). It can be avoided by adjust smaller proportion gain and longer integral time.

F8.27	ASR(VF) slip limit	Setting range:0.0-500.0%	Factory set: 100.0%
-------	--------------------	--------------------------	---------------------

It is used to limit the max slip frequency compensation. It can be properly bigger for high accuracy required or heavy load

9.10 Tension control special parameters

F9.00	Tension setting selection	Setting range:0000-0566	Factory set: 0000
-------	---------------------------	-------------------------	-------------------

LED "0" digit: main channel selection

0: Keyboard No give [F9.03] keyboard No set frequency to give or modify main channel tension

1: Keyboard pot give or modify

2: VS1 give or modify

3: VS2 give or modify

4: AS give or modify

5: PUL give or modify

6:RS485 give

LED "00" digit: Second channel selection

0: Keyboard give [F7.01] keyboard No set frequency give or modify.

- 1: Keyboard pot give or modify
- 2: VS1 give or modify
- 3: VS2 give or modify
- 4: AS give or modify
- 5: PUL give or modify
- 6:RS485 give

LED "000" digit: Main channel combines second channel

0: Main×[F9.01]

1: Second×[F9.02]

2: Main×[F9.01] + second×[F9.02]

3: Main×[F9.01] — second×[F9.02]

4: MAX {Main×[F9.01], second×[F9.02]}

5: MIN {Main×[F9.01], second×[F9.02]}

LED "000" digit: Reserved

F9.01	Tension give main channel gain	Setting range:0-500.0%	Factory set: 100.0%
F9.02	Tension give second channel gain	Setting range:0-500.0%	Factory set: 100.0%

Tension give main channel gain zooms in or out tension values, adjust the main channel tension by ratio.

Tension give second channel gain zooms in or out tension values, adjust the second channel tension by ratio.

F9.03	Tension No setting	Setting range:0-30000N	Factory set: 0
-------	--------------------	------------------------	----------------

While keyboard No give tension channel, it is used to set and modify keyboard No give tention.

F9.04	Max tension	Setting range:0-30000N	Factory set:0
-------	-------------	------------------------	---------------

While keyboard No give tension channel, it is max tension inverter permit to set.

F9.05	Tension tape coefficient	Setting range:0.0-100.0%	Factory set:0.0%
-------	--------------------------	--------------------------	------------------

It is used to control winding material moulding under winding mode. In winding process, sometime tension needs reduce while roll diameter increase to make sure good winding moulding.

$$\text{output tension} = \text{set tension} \times \left\{ 1 - \text{tension tape} \times \left[1 - \frac{(\text{Initial diameter} + \text{Tape compensate modify})}{(\text{Actual diameter} + \text{Tape compensate modify})} \right] \right\}$$

While the tape coefficient is bigger, tension will reduces quicker and quicker as the diameter increase in winding process. Otherwise, it will be different. While tension tape need adjust. It can be modified by [F9.06] tape compensation modify.

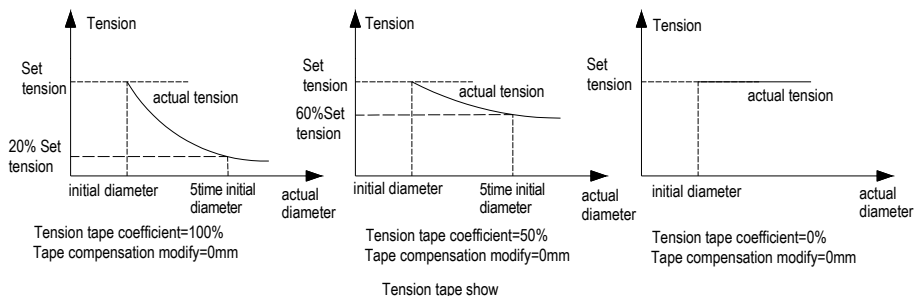

F9.06	Tape compensation modify	Setting range:0-10000mm	Factory set: 0
-------	--------------------------	-------------------------	----------------

It is tension tape control assistant parameter. Increase this value after settle down the tension tape can make output tension decrease slowly while roll diameter increase. Otherwise, decrease it can make output tension increase quickly while roll diameter increase.

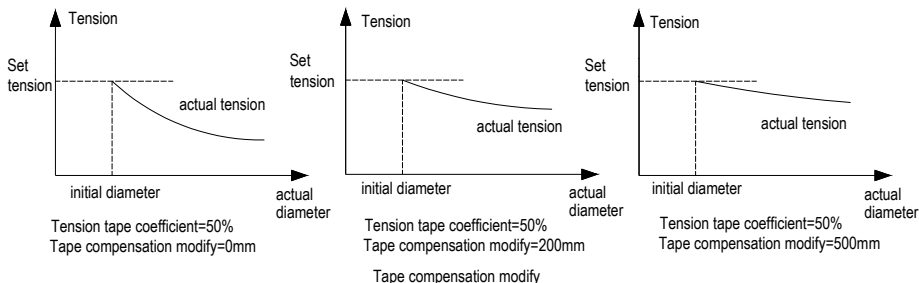

F9.07- F9.08	Reserved
--------------	----------

F9.09	Machine drive ratio	Setting range:0.01-300.00	Factory set:1.00
-------	---------------------	---------------------------	------------------

Machine drive ratio: It means the deceleration ratio of the drive motor output speed and winding reel speed or unwinding reel speed.

$$\text{Machine drive ratio} = \text{motor output speed} / \text{winding reel speed}$$

It is very important in the tension control process. It must rightly set the machine drive ratio.

F9.10	Curl mode	Setting range:0-1	Factory set:0
-------	-----------	-------------------	---------------

Select Curl mode to supply two shortcut for winding and unwinding

0: Winding Under winding tension control, tension direction is fixed to be winding tension direction, consistent to the run direction under speed control.

1: Unwinding Under unwinding control, tension direction is opposite to syterm control run direct. While no load, run direction also opposite to the normal unwinding direction.

F9.11	Roll diameter calculation selection	Setting range:0-8	Factory set: 0
-------	-------------------------------------	-------------------	----------------

This parameter is used to select the roll diameter calculation method or the roll diameter input mode. In the process of winding, diameter calculation directly affects the inverter tension control. The reasonable roll diameter input ways helps to better control the tension.

- 0: Initial roll diameter, no calculate the inverter not counting the unwinding roll diameter, default for the initial roll diameter.
- 1: Line speed calculate inverter calculates roll diameter based on the line speed and the inverter output frequency. line speed source selection see [F9.25]. The advantage of this method is it has nothing to do with the material thickness and can get acceleration speed of system.
- 2: Calculate through the accumulative thickness Need to set the thickness of the material. The inverter calculates roll diameter according to cumulative calculation of the winding reel circle signal. While winding, it is increase gradually. Related functions see [F9.36-F9.41] accumulative thickness calculate roll diameter parameters.
- 3: Calculate through the time Need the full winding roll diameter and the time to arrive full roll. Inverter calculates the roll diameter of the middle time by the upper parameters. The method is suitable for the traction line speed constant and the winding max roll diameter fixed occasions. This feature provides two sets of switch parameters, see parameter [F9.44-F9.48].
- 4: Keyboard potentiometer give winding roll diameter
- 5: VS1 give winding roll diameter, VS1 input analog filter details see [F3.04]
- 6: VS2 give winding roll diameter, VS1 input analog filter details see [F3.04]
- 7: AS give winding roll diameter, VS1 input analog filter details see [F3.04]
- 8: PUL give winding roll diameter, PUL max frequency is corresponding to max roll diameter.
- 9: RS485 give winding roll diameter**

Note: While analog give, the max analog input is linear relation with [F9.12] max roll diameter.

F9.12	Max roll diameter	Setting range:1-10000mm	Factory set:500
-------	-------------------	-------------------------	-----------------

Max roll diameter: Max roll diameter while winding, corresponding to the max input value while [F9.11] is analog input. And they are linear relationship.

While [F9.11] roll diameter resource is Line speed calculates, Calculate through the accumulative thickness or Calculate through the time, the result is limited by max roll diameter. It should be modified after calculate the max roll diameter.

F9.13	Reel diameter	Setting range:1-10000mm	Factory set:100
-------	---------------	-------------------------	-----------------

Reel diameter: The diameter while winding roll is empty. Inverter also takes it as the initial diameter and the lower diameter limit. It is very important to set the reel diameter rightly. If not right, as inverter takes it as lower roll diameter limit, tension control will meet problem while the roll diameter is lower than this value.

F9.14	Initial diameter resource selection	Setting range:0-5	Factory set:0
-------	-------------------------------------	-------------------	---------------

It is used to select the initial diameter give mode.

- 0: Terminal select Select initial diameter by switch terminals. Details see [F9.15-F9.17]

- 1: Keyboard potentiometer give or modify
- 2: VS1 give or modify
- 3: VS2 give or modify
- 4: AS give or modify
- 5: PUL give or modify

F9.15	Initial diameter 1	Setting range:1-10000mm	Factory set:100
F9.16	Initial diameter 2	Setting range:1-10000mm	Factory set:100
F9.17	Initial diameter 3	Setting range:1-10000mm	Factory set:100

While Initial diameter resource selection [F9.14] is set as "0(Terminal select)", it can be select "Initial diameter setting terminal" to define any terminals. Details see [F2.00-F2.07]; 3 groups of Initial diameter can be supplied by terminal switch. The relationship table is as below.

Initial diameter set 1	Initial diameter set 2	Initial diameter
ON	OFF	Initial diameter 1
OFF	ON	Initial diameter 2
ON	ON	Initial diameter 3

Note: while all terminals are OFF state, Initial diameter is reel diameter [F9.13] setting. If need modify by RS485, set [F9.14] as "0" and not define terminal. Modify Initial diameter in [F9.13] address of upper machine.

F9.18	Diameter reset selection	Setting range:0-1	Factory set: 0
-------	--------------------------	-------------------	----------------

0: Manual reset Need define one terminal as "diameter reset terminal". While diameter reset terminal is valid, the roll diameter of the inverter reset to initial diameter.

1: Auto reset Inverter resets the roll diameter to initial value automatically after stop.

F9.19	Diameter filter time	Setting range:0.1-100.0s	Factory set:1.0s
-------	----------------------	--------------------------	------------------

It defines the filter time for roll diameter to clear outside disturbance to the roll diameter. The longer the time is, the stronger the anti-disturb ability is. Roll diameter change respond speed will be weaker. The shorter the time is, the weaker the anti-disturb ability is. Roll diameter change respond speed will be quicker.

Under tension control, if torque wave is obvious, diameter filter time can be increased properly to prevent the torque wave for diameter calculate not stable.

F9.20	Current roll diameter	Setting range:1-10000mm	Factory set: *
-------	-----------------------	-------------------------	----------------

This parameter can monitor the current roll diameter in real time. It can be compared to the actual diameter while debugging. The current roll diameter can be adjusted by this parameter.

F9.21	Roll diameter calculate end frequency	Setting range:0.00-50.00Hz	Factory set:10.00
-------	---------------------------------------	----------------------------	-------------------

Set the lowest frequency where begin to calculate the roll diameter. While the output frequency is lower this value, frequency inverter stop roll diameter calculate. Right setting can prevent big error of roll diameter calculate at low speed.

F9.22	Diameter reset delay	Setting range:0-6000s	Factory set:10
-------	----------------------	-----------------------	----------------

It is used to clear the diameter calculate error at start. Right setting can prevent the calculate error at beginning of winding.

F9.23-F9.24	Reserved
-------------	----------

Linear calculate

F9.25	Linear input resource	Setting range:0-6	Factory set:0
-------	-----------------------	-------------------	---------------

It is valid only while [F9.11] is set as "1"

0: F9.28/F9.29 terminal selection Select traction linear value by terminal switch , details see[F9.28-F9.29]

1: Keyboard potentiometer gives and modifies

2: VS1 give and modify

3: VS2 give and modify

4: AS give and modify

5: PUL give and modify

6: $PUL * ((F9.31) * \pi / (F9.32))$ While the traction roller adopts photoelectric switch to detect speed, it calculates traction roller speed by the photoelectric switch frequency, traction roller diameter and pulse per cycle. The formula is:

$$\text{Traction linear speed} = PUL * \text{traction roller diameter} * \pi / \text{pulse per cycle}$$

7: RS485 give and modify

Note: While using linear calculate in winding, it must gain right traction linear speed. The normal way is sending output frequency of the inverter who drives traction motor to winding inverter to gain run frequency of traction.

F9.26	Max linear speed	Setting range:0.0-6500.0m/Min	Factory set:1000.0
-------	------------------	-------------------------------	--------------------

Max linear speed of traction. While the linear resource is analog input, the analog input max value and max linear speed are linear corresponding relationship.

F9.27	Min linear speed of diameter calculate	Setting range:0.0-6500.0m/Min	Factory set:200.0
-------	--	-------------------------------	-------------------

Set the lowest linear speed where begin to calculate roll diameter. While inverter detect the linear speed is lower than this value, inverter stop calculate. Right setting can prevent error at low speed. While setting linear calculate, this parameter and the end frequency both are valid. The bigger value is the lowest value where stop calculate.

F9.28	Linear speed setting 1	Setting range:0.0-6500.0m/Min	Factory set:1000.0
F9.29	Linear speed setting 2	Setting range:0.0-6500.0m/Min	Factory set:1000.0

While [F9.25] Linear input resource is 0: F9.28/F9.29 terminal selection. It can select linear speed selection terminal and define any terminals, details see [F2.00-F2.07]. Set traction linear speed by terminal switch can bring two group traction linear speed. Relationship table as below:

Linear speed selection terminal	linear speed setting
OFF	Linear speed setting 1
ON	Linear speed setting 2

F9.30	Current linear speed	Setting range:0.0-6500.0m/Min	Factory set:*
-------	----------------------	-------------------------------	---------------

Monitor the current linear speed in real time.

F9.31	Traction roller diameter	Setting range:0.0-1000.0mm	Factory set:100.0mm
F9.32	Traction roller pulse per cycle	Setting range:1-60000	Factory set:1

While [F9.25] Linear input resource is 6, inverter gains traction linear speed by detection traction roller pulse signal. It needs traction roller pulse per cycle and traction roller diameter.

Traction roller pulse per cycle: Nos of pulse per cycle of the traction roll in winding process.

F9.33 -F9.35	Reserved
--------------	----------

Thickness calculate:

F9.36	Pulse per cycle	Setting range:1-60000	Factory set:1
F9.37	Cycles per layer	Setting range:1-10000	Factory set:1

While roll diameter calculation selection [F9.11] is 2, [F9.36-F9.41] are valid. PUL port is pulse input port default.

Inverter calculates the thickness by pulse from PUL port.

Pulse per cycle: Pulse is coming from one cycle in winding process.

Cycles per layer: Cycles which are needed for one layer of winding roll finish.

F9.38	Max thickness	Setting range:0.01-100.00mm	Factory set:1.00
-------	---------------	-----------------------------	------------------

Max thickness of material permit. While thickness is analog input, max analog input corresponds to the max thickness. And they are linear relationship.

F9.39	Material thickness set resource	Setting range:0-5	Factory set: 0
-------	---------------------------------	-------------------	----------------

It is used to select material thickness gain mode:

0: F9.40/F9.41 terminal select Select material thickness by terminals switch. details see [F9.40-F9.41].

1: Keyboard potentiometer gives and modifies the material thickness.

2: VS1 gives and modifies the material thickness.

3: VS2 gives and modifies the material thickness.

4: AS gives and modifies the material thickness.

5: PUL gives and modifies the material thickness.

6: RS485 gives and modifies the material thickness.

F9.40	Material thickness 1	Setting range:0.01-100.00mm	Factory set:0.01mm
F9.41	Material thickness 2	Setting range:0.01-100.00mm	Factory set:0.01mm

While Material thickness set resource [F9.39] is "0",It can select "material thickness selection terminal" to define any terminals. Details see [F2.00-F2.07] Set thickness by terminal switch can bring two group traction linear speed.

Relationship table as below:

Material thickness selection terminal	Material thickness
OFF	Material thickness 1
ON	Material thickness 2

F9.42	Reserved
F9.43	Reserved

Time calculate:

F9.44	Full roll diameter 1	Setting range:1-10000mm	Factory set:500
F9.45	Full roll diameter 2	Setting range:1-10000mm	Factory set:500

While roll diameter calculation selection [F9.11] is 3, [F9.44-F9.48] are valid. It can set full roll diameter by terminal switch.It can select "full roll diameter selection terminal" to define any terminals. Details see [F2.00-F2.07] Set full roll diameter by terminal switch can bring two group full roll diameter. Relationship table as below:

Full roll diameter selection	Full roll diameter
OFF	Full roll diameter 1
ON	Full roll diameter 2

F9.46	Empty to full roll time 1	Setting range:0-65000s	Factory set:3600
F9.47	Empty to full roll time 2	Setting range:0-65000s	Factory set:7200

It sets the time from empty roll to full roll. It can set empty to full roll time by terminal switch.It can select "empty to full roll time selection terminal" to define any terminals. Details see [F2.00-F2.07]. Set empty to full roll time by terminal switch can bring two groups empty to full roll time. Relationship table as below:

Empty to full roll time selection	Empty to full roll time
OFF	Empty to full roll time 1
ON	Empty to full roll time 2

F9.48	Current time	Refer range:0-65000s	Factory set:*
-------	--------------	----------------------	---------------

It is used to monitor winding run time in real time.

F9.49-F9.51	Reserved
-------------	----------

9.11 Malfunction and protection parameters

FA.00	Protection functionselection 1	Setting range: 0000-0111	Factory set: 0001
-------	--------------------------------	--------------------------	-------------------

LED "0" digit: ACC OC protection selection

0: Invalid

1: **Valid** While inverter output frequency is over [FA.15] setting, inverter enters OC protection state, prolong ACC time and not continue ACC until frequency back to [FA.15] setting.

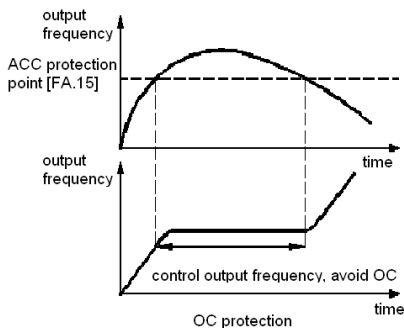

LED"00"digit: DEC OC protection selection

While inverter output frequency is over [FA.16] setting, inverter enters OC protection state, prolong DEC time and not continue DEC until frequency back to [FA.16] setting.

0: Invalid

1: Valid

LED"000"digit: current limit selection while running

While inverter output frequency is over [FA.17] setting, inverter enters current limit state, reduce output frequency according to [FA.18] ACC/DEC time setting and not continue ACC according to [FA.18] ACC/DEC time setting until frequency back to [FA.17] setting.

0: Invalid

1: Valid

LED"0000"digit: reserved

FA.01	Protection function selection 2	Setting range: 0000-3212	Factory set: 0001
-------	---------------------------------	--------------------------	-------------------

LED "0" digit: DEC OV protection selection

0: Invalid

1: **rating 1 OV protection** Stronger OV protection. Bus voltage wave is small while protection.

2: **rating 2 OV protection** Strongest OV protection. Bus voltage wave is big while protection.

While it is valid and bus voltage is reach or over [FA.05], inverter will stop DEC.

LED"00"digit: Protection selection for OV in ACC or constant speed

0: Invalid

1: Valid While bus voltage is reach or over [FA.06], inverter will adjust frequency to protect. It is valid specially for eccentric load

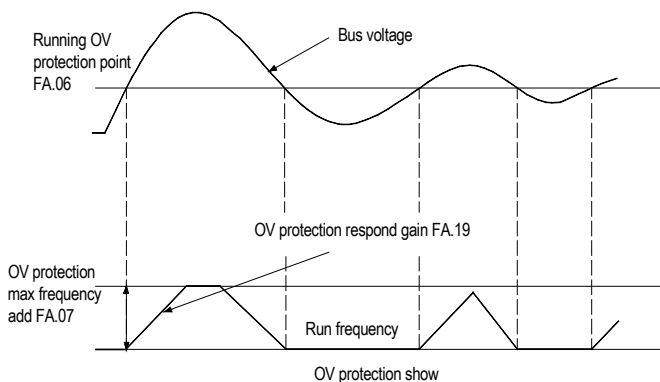

Note: Set right [FA.07] and [FA.19] parameters while using the OV protection.

LED“000”digit: inverter OL act Set protection mode while over load.

0: emergency stop output and alarm While OL protection action is caused by too big output current of inverter, inverter stops output. Motor freely stop. And inverter alarm fault E.oL2.

1: emergency stop and alarm While OL protection action is caused by too big output current of inverter, inverter stops. Motor DEC stop. And inverter alarm fault E.oL2.

2: limit current and run While OL protection action is caused by too big output current of inverter, inverter switches to current limited run. Inverter makes output current be limited within rated current by reduce output frequency actively.

LED “0000” digit: motor OL act

0: emergency stop output and alarm While OL protection action is caused by too big output current of motor, inverter stops output. Motor freely stop. And inverter alarm fault E.oL1.

1: emergency stop and alarm While OL protection action is caused by too big output current of motor, inverter stops. Motor DEC stop. And inverter alarm fault E.oL1.

2: limit current and run While OL protection action is caused by too big output current of motor, inverter switches to current limited run. Inverter makes output current be limited within rated current by reduce output frequency actively.

3: motor OL protection off

Note: If “emergency stop and alarm” is selected while inverter or motor OL, inverter will do like this:

1: After enter emergency stop state; inverter does not accept any orders including fault reset order until emergency stop state end.

2: In emergency stop process, fault signal is output immediately while multi function output terminal is set as fault jump alarm 1. Fault signal is output after inverter DEC finished while multi function output terminal is set as fault jump alarm 2.

3: In emergency stop process, Keyboard LED displays fault information.

FA.02	Protection function selection 3	Setting range: 0000-1112	Factory set: 0110
-------	---------------------------------	--------------------------	-------------------

LED “0”digit: inverter OH protection selection

0: emergency stop output and alarm While OH protection action is caused by too high temperature of inverter, inverter stops output. Motor freely stop. And inverter alarm fault E.OH1.

1: emergency stop and alarm While OH protection action is caused by too high temperature of inverter, inverter stops. Motor DEC stop. And inverter alarm fault E.OH1.

2: limit current and run While OH protection action is caused by too big output current of inverter, inverter switches to

current limited run. Inverter reduces current by reduce output frequency actively. Temperature be limited within70℃

LED“00”digit: input phase lack protection selection

0: Invalid

1: Valid Stop inverter output and alarm fault E.ILF while detect input phase lack.

LED“000”digit: output phase lack protection selection

0: Invalid

1: Valid Stop inverter output and alarm fault E.oLF while detect output phase lack.

LED“0000”digit: reserved

FA.03	Protection function selection 4	Setting range: 0000-0011	Factory set: 0000
-------	---------------------------------	--------------------------	-------------------

LED “0”digit: SC protection selection

0: Invalid

1: Valid. Inverter judges E.SC alarm and removes distrubabce, only alarm for real fault signal. This function maybe delay alarm time. Please ust it carefully.

LED“00”digit: OC protection selection

0: Invalid

1: Valid Inverter judges OC alarm and remove distrubabce, only alarm for real fault signal. This function maybe delay alarm time. Please ust it carefully.

LED“000”digit: reserved

LED“0000”digit: reserved

FA.04	Fan control	Setting range: 0-2	Factory set: 1
-------	-------------	--------------------	----------------

Select fan run mode.

0: Fan run after electrify No matter temperature of module is high or not, fan runs while inverter power on.

1: Fan stop related to temperature Work while running. While inverter stops, fan runs while module temperature is over 50 degree and stops 30 seconds after module temperature is lower then standard. While inverter runs, fan runs.

2: Fan stop while machine stop, run related to temperature While inverter runs, fan runs while module temperature is over 50 degree and stops 30seconds after module temperature is lower then standard. While inverter is stops, fan stops.

Note: This function can prolong fan life.

FA.05	DEC OV protection	Setting range:110-150%	Factory set:120%
FA.06	Running OV protection point	Setting range:100-150%	Factory set:115%

Inverter DC bus rated voltage=inverter input rated voltage*1.414

DEC OV protection: Set OV protection point while DEC. Only valid while [FA.01] LED “0” digit is 1.

Running OV protection point: Set OV protection point while ACC or running at constant speed. Only valid while [FA.01] LED “0” digit is 1.

FA.07	OV protection max frequency add	Setting range: 0-50.00Hz	Factory set:2.00Hz
-------	---------------------------------	--------------------------	--------------------

OV protection max frequency add: Frequency inverter usually adds frequency to restrain the temperature rise while bus voltage is higher than [FA.06]. It limits the frequency adding range.

Note: 1, Increase this value can better restrain, but if too big, the speed maybe shakeing. 2, If the bus voltage

increase quickly and even not stop increase while adding frequency, then should increase [FA.19] to improve the protection respond speed.

FA.08	Energy braking act voltage	Setting range: 115.0-140.0%	Factory set: 120.0%
-------	----------------------------	-----------------------------	---------------------

Energy braking act voltage: Inverter energy braking begins while DC bus voltage rise up and over rated.Voltage [FA.08] setting. Voltage is DC20V lower than [FA.08] setting while energy braking stops. Please set it carefully. It is only valid for inverter with inner braking parts. Inverters under AC90-T3-018T have build in braking parts. AC90-S2-3R7T and inverters under than that with 220V input have built in braking parts. All inverters do not have resistances. If need energy braking, please use optional resistance.

Note: If use energy braking, please close OV protection function. What mens set [FA.01] LED “0”digit and “00” digit as 0. Energy braking only be valid in running, invalid while stop.

FA.09	Reserved		
-------	----------	--	--

FA.10	Bus under-voltage protection	Setting range:50.0-100.0%	Factory set:60.0%
-------	------------------------------	---------------------------	-------------------

It sets the lowest voltage limitation of DC side while inverter works normally. In location with lower grid, under-voltage protection level can be reduced to keep inverter work normally.

Note: Too low grid voltage reduces inverter reliability.

FA.11	Speed fall act voltage at sudden power down	Setting range: 0-200%	Factory set: 20%
FA.12	Main circuit aim voltage at sudden power down	Setting range: 0-200%	Factory set: 90%
FA.13	Speed fall gain at sudden power down	Setting range: 0.01-10.00	Factory set: 2.00
FA.14	Speed back waiting time at sudden power down	Setting range: 0.1-100.0s	Factory set: 2.0s

Inverter reduces output frequency and compensates voltage by feedback energy while sudden power down.

While input voltage is lower than [FA.11], inverter begins DEC. Bus voltage rise up back. While voltage back to [FA.12], it stop DEC. Inverter run at stable speed for [FA.14] time and ACC to frequency setting.

[FA.13] is DEC time gain. Voltage rises up more quickly while it is bigger. It is suitable for small inertia load. Voltage rises up more slowly while it is smaller. It is suitable for big inertia load.

FA.15	ACC OC protection point	Setting range: 100-250%	Factory set: 160%
FA.16	DEC OC protection point	Setting range: 100-250%	Factory set: 160%
FA.17	Current limit level while running	Setting range: 100-250%	Factory set: 160%
FA.18	Current limit frequency ACC/DEC time while running	Setting range: 0.00-650.00s	Factory set: 10.00s

OC protection point=inverter output current/inverter ratted current. 100% is rated current.

ACC OC protection point

DEC OC protection point

Current limit level while running

Current limit frequency ACC/DEC time while running

FA.19	OV protection respond gain	Setting range: 0-10.0	Factory set: 0.2
-------	----------------------------	-----------------------	------------------

OV protection responds gain: It track and adjust while OV protection process. The frequency inverter adjusts the frequency adding according to the bus voltage increasing rate and actual bus voltage. Increasing the respond gain can improve the respond speed. But it makes the speed shake.

FA.20	Reserved		
-------	----------	--	--

FA.21	Motor overload protective coefficients	Setting range: 20.0-250.0%	Factory set: 100.0%
-------	--	----------------------------	---------------------

While motor overload for long time, it will over heat. This parameter is used to set coefficients of the frequency inverter relay protection to the motor.

Motor OL protection coefficients =motor protection coefficients / motor rated coefficients

While one inverter for multi-motor, this function does not work. To protect motor, please install heat protection relay at every motor input terminal.

FA.22	Malfunction auto-reset times	Setting range: 0-5	Factory set: 0
FA.23	Malfunction auto-reset interval	Setting range: 0.1-100.0s	Factory set:1.0s

Malfunction auto-reset times:

0: Off No automatic reset function.

1-5: On 1-5 is times of automatic reset after fault.

Output terminal can be selected to act or not act in automatic reset process. Details refer to [F2.29-F2.31].

Malfunction auto-reset interval: It defines waiting time before resetting after fault.

Note: 1. This function is only valid for fault of OL, OC, system abnormality, under voltage. Not valid for other faults.

2. Can not reset before dealing with malfunction.

Attention: Please use this function carefully in occasions that can not start with load, or that needs alarm immediately while inverter no output.

FA.24	Reserved		
-------	----------	--	--

FA.25	Malfunction types	Please see malfunction code table	--
FA.26	Malfunction running frequency	0.00-max frequency	--
FA.27	Malfunction output voltage	0-1500V	--
FA.28	Malfunction output current	0.1-2000.0A	--
FA.29	Malfunction bus voltage	0-3000V	--
FA.30	Malfunction module temperature	0-100℃	--
FA.31	Malfunction machine	LED "0" digit: run direction	--

	state	0: REV 1: REV LED "00" digit: run state 0:stop 1:stable speed 2:ACC 3:DEC LED "000" digit: reserved LED "0000" digit: reserved	
FA.32	Malfunction input terminal state	See input terminal chart	--
FA.33	Malfunction output terminal state	See input terminal chart	--
FA.34	The last 1 malfunction types	Please see malfunction code table	--
FA.35	The last 1 malfunction running frequency	0.00-max frequency	--
FA.36	The last 1 malfunction output voltage	0-1500V	--
FA.37	The last 1 malfunction output current	0.1-2000.0A	--
FA.38	The last 1 malfunction bus voltage	0-3000V	--
FA.39	The last 1 malfunction module temperature	0-100℃	--
FA.40	The last 1 machine state	LED "0" digit:run direction 0: REV 1: REV LED "00" digit:run state 0:stop 1:stable speed 2:ACC 3:DEC LED "000" digit:reserved LED "0000" digit:reserved	--
FA.41	The last 1 malfunction input terminal state	See input terminal chart	--
FA.42	The last 1 malfunction output terminal state	See input terminal chart	--
FA.43	The last 2 malfunction types	Please see malfunction code table	--
FA.44	The last 3 malfunction types	Please see malfunction code table	--

Note: Malfunction records can be cleared by [F0.19]. See [F0.19] details.

9.12 Machine malfunction code table

Communication code	Malfunction code	Malfunction LED code	Malfunction name
0	--	--	No fault
1	L.U.1	L.U.1	Under-voltage at stop
2	E.LU2	E.LU2	Under-voltage while running
3	E.oU1	E.oU1	Over-voltage while ADD
4	E.oU2	E.oU2	Over-voltage while DEC
5	E.oU3	E.oU3	Over-voltage at constant speed
6	E.oU4	E.oU4	Over-voltage at stop
7	E.oC1	E.oC1	Over-current while ADD
8	E.oC2	E.oC2	Over-current while DEC
9	E.oC3	E.oC3	Over-current at constant speed
10	E.oL1	E.oL1	Motor overload
11	E.oL2	E.oL2	Frequency inverter overload
12	E. SC	E. SC	System abnormal
13	E.oH1	E.oH1	Inverter overheat
14	E.oH2	E.oH2	Rectifier bridge overheat
15	E.tE1	E.tE1	Motor detect malfunction at static state
16	E.tE2	E.tE2	Motor detect malfunction circularly
17	E.EEP	E.EEP	Store malfunction
18	L.IFE	L.IFE	Reserved
19	E.iLF	E.iLF	Input side phase lack
20	E.oLF	E.oLF	Output side phase lack
21	E.GnD	E.GnD	Output earth
22	E.HAL	E.HAL	Current detection fault
23	E.EF	E.EF	Exterior fault
24	E.PAn	E.PAn	Keyboard connection fault
25	E.CE	E.CE	Rs485 communication fault
26	E.CPE	E.CPE	Parameter copy fault
27	E.ECF	E.ECF	Optional card connection fault
28	E.PG	E.PG	PG card connection fault
29	E.PID	E.PID	PID feedback wire connection fault
30	E.EDI	E.EDI	Copy software not compatible

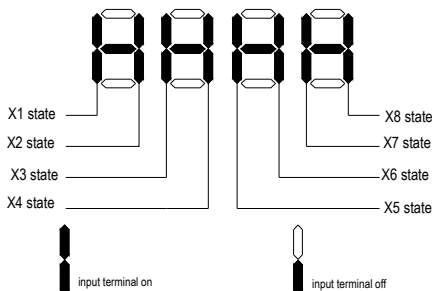
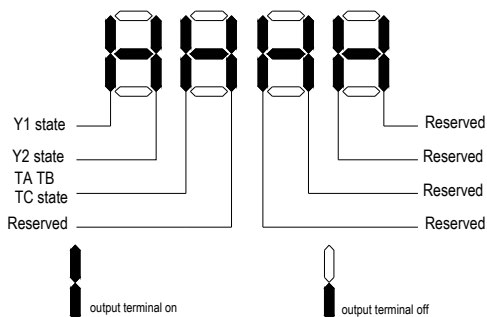
Input terminal on/off show diagram:**Output terminal on/off show diagram:****9.13 PID parameters**

PID control is used for process control mode normal. For the aim of that the object which be controlled is stabilized as the PID given, it adjusts inverter output frequency to form passive feedback PID adjustment by series of proportional, integral, differential calculation by difference between the feedback of that be controlled and the inverter PID given.

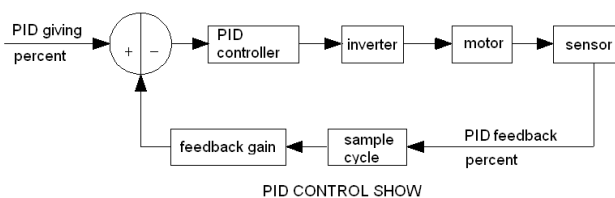

Fb.00	PID give signal source	Setting range: 0-8	Factory set: 0
-------	------------------------	--------------------	----------------

Use to set the input channel of PID controller given signal.

0: Keyboard number given PID Decided by [Fb.01] setting.

1: Keyboard potentiometer

2: Terminal VS1 voltage analog

3: Terminal VS2 voltage analog

4: Terminal AS current analog

5: Terminal PUL pulse signal

6: RS485 communication

7: Optional card

8: Terminal selection PID giving is selected by multifunction input terminal combine which is set by [F2.00-F2.07].

Terminal switch table:

Terminal 3	Terminal 2	Terminal 1	PID giving terminal switch selection
OFF	OFF	OFF	Keyboard number give PID
OFF	OFF	ON	Keyboard potentiometer
OFF	ON	OFF	Terminal VS1 voltage analog
OFF	ON	ON	Terminal VS2 voltage analog
ON	OFF	OFF	Terminal AS current analog
ON	OFF	ON	Terminal PUL pulse signal
ON	ON	OFF	RS485 communication
ON	ON	ON	Optional card

Fb.01	Keyboard number give PID	Setting range: 0.00-100.0%	Factory set: 50.0%
-------	--------------------------	----------------------------	--------------------

This function is valid only when [Fb.00]/[Fb.02] is set as keyboard number given/feedback. It is based on feedback signal max range [Fb.04]. After this parameter is changed, PID given in monitor object is modified automatical at the same time.

If [Fb.04] LED "0" is set as 3, this value can be modified by UP/DW key. Whether save the modification is decided by [F4.04] LED "00" digit.

Fb.02	PID feedback signal source	Setting range:0-8	Factory set:2
-------	----------------------------	-------------------	---------------

Set PID feedback signal input channel.

0: Keyboard number given PID PID feedback channel decided by [Fb.01].

1: Keyboard potentiometer

2: Terminal VS1 voltage analog

3: Terminal VS2 voltage analog

4: Terminal AS current analog

5: Terminal PUL pulse signal

6:RS485 communication PID feedback channel decided by RS485.Communication address is H3009 or H2009.

7: Optional card

8: Terminal selection PID feedback channel decided by multifunction input terminal combination. Multifunction input terminal is set by [F2.00-F2.07].

Terminal switch table:

Terminal 3	Terminal 2	Terminal 1	PID giving terminal switch selection
OFF	OFF	OFF	Keyboard number give PID
OFF	OFF	ON	Keyboard potentiometer
OFF	ON	OFF	Terminal VS1 voltage analog
OFF	ON	ON	Terminal VS2 voltage analog
ON	OFF	OFF	Terminal AS current analog
ON	OFF	ON	Terminal PUL pulse signal
ON	ON	OFF	RS485 communication
ON	ON	ON	Optional card

Note: PID controller given signal source and PID controller feedback signal source can not be the same channel. Otherwise PID can not work normally.

Fb.03	Feedback signal gain	Setting range: 0.00-10.00	Factory set: 1.00
-------	----------------------	---------------------------	-------------------

It is used to magnify or reduce feedback channel input signal.

Fb.04	Feedback signal max measuring range	Setting range: 0-100.0	Factory set: 100.0
-------	-------------------------------------	------------------------	--------------------

It is used to revise the display data of PID given and PID feedback.

$$\text{Display data} = \frac{\text{give/feedback signal-lowest limit value for this channel}}{\text{highest limit value for this channel-lowest limit value for this channel}} \times \frac{\text{max sensor}}{\text{measuring range}}$$

For example: Under pressure control, while it is set as sensor max measuring range, it displays actual pressure.

If VS1 is feedback signal input channel, while VS1 highest limit is 9V, lower limit is 0.5V, feedback voltage is 4.5V, and sensor measuring range is 20mpa.

$$\text{Display value} = (4.5-0.5) \times 20/(9-0.5) = 9.4\text{mpa}$$

Fb.05	PID output trait selections	Setting range: 0000-0011	Factory set: 0100
-------	-----------------------------	--------------------------	-------------------

LED "0" digit: feedback trait

0: Positive trait. It is suitable for occasions where PID feedback is bigger than PID given and requires reduce output frequency PID to balance PID. Such as constant pressure water supply, gas supply, take-up tension control.

1: Negative trait. It is suitable for occasions where PID feedback is bigger than PID given and requires raise output frequency PID to balance PID. Such as constant temperature control, pay-off tension control.

LED "00" digit: PID direction adjustment

0: REV forbid

1: REV permit

Inverter control output frequency after given signal and feedback signal calculation according to PID control mode setting while receiving the run order. If REV forbid ([F0.07] LED "00" digit is 0 frequency control direction invalid or [F0.16] is 2 REV forbid), inverter outputs 0.00Hz. If REV permit, inverter will change output direction, motor REV.

LED "000" digit: align

While PID setting is not at the centre point of 50%, error range of PID feedback and PID setting is non-symmetry state.

0: not centre align Not correct error.

1: centre align Correct error.

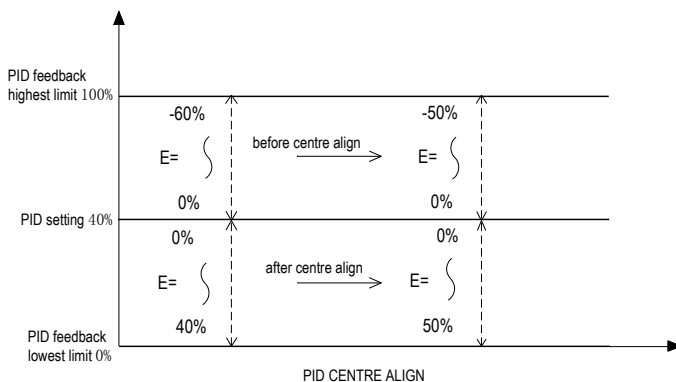

LED "0000" digit: reserved

Fb.06	PID preset frequency	Setting range: 0.00-max frequency	Factory set: 50.00Hz
Fb.07	PID preset frequency running time	Setting range: 0.0-6500.0s	Factory set: 0.0s

While it defines as PID start running, frequency ACC to PID pre-set frequency [Fb.06] according to ACC time 1. After setting [Fb.07] time, it runs as PID closed loop trait.

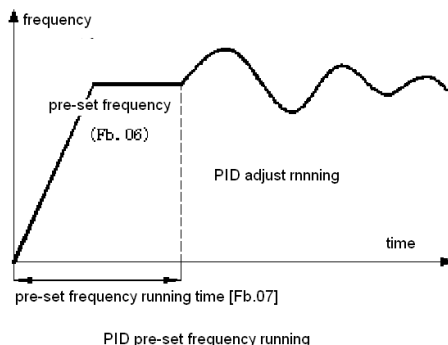

Fb.08	Proportion gain: P	Setting range: 0.00-100.00	Factory set: 1.00
Fb.09	Integral time: I	Setting range: 0.01-10.00s	Factory set: 0.10s
Fb.10	Differential coefficient : D	Setting range: 0.00-10.00s	Factory set: 0.00s

Proportion gain P: It decides the impact of P act to bias. Response is quicker while gain is bigger. But there will be surge while it is too big. Response is slower while gain is smaller.

Integral time I: It decides the size of effect of I act. Response is slower and control ability for out disturbance while I is big. Response is quicker while I is small. But there will be surge if it is too small.

Differential coefficient D: While bias of PID feedback and PID given is changing, it adjusts change rate of output and bias pro rata. It is related to direction and size of bias change, not related to direction and size of bias itself. Use it carefully for it easily magnifies the disturbance.

Fb.11	Sample cycle	Setting range: 0.01-100.00s	Factory set: 0.10s
-------	--------------	-----------------------------	--------------------

It is only valid for PID feedback sample cycle. Response is quicker while cycle is smaller.

Fb.12	PID slip limit	Setting range: 0.0-100.0%	Factory set: 0.0%
-------	----------------	---------------------------	-------------------

While feedback is in this range, PID adjustment stops. Output does not change.

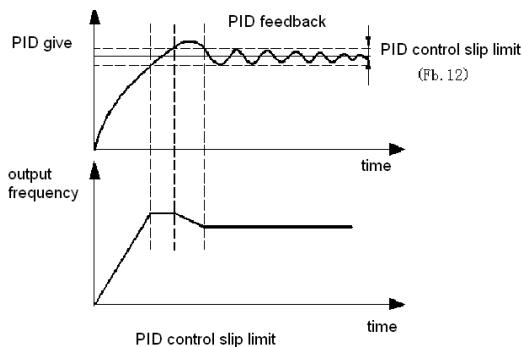

Fb.13	Reserved		
-------	----------	--	--

Fb.14	Detection time while feedback wire break	Setting range: 0.0-6500.0s	Factory set: 1.0s
Fb.15	Act selections while feedback wire break	Setting range: 0-3	Factory set: 0
Fb.16	Wire break alarm upper limit	Setting range: 0.0-100.0%	Factory set: 100.0%
Fb.17	Wire break alarm lowest limit	Setting range: 0.0-100.0%	Factory set: 0.0%

While PID given frequency and inverter is running, if feedback signal which is bigger the **[Fb.16]** or smaller than **[Fb.17]** is detected out and keeps for **[Fb.14]** delay time, it is considered as sensor wire break.

Act selections while feedback wire break:

- 0: Go on PID operation without alarm
- 1: Stop and alarm malfunction
- 2: Go on PID operation and output alarm signal
- 3: Run the current frequency and output alarm signal

Wire break alarm upper limit: Feedback signal is over alarm upper limit for time **[Fb.14]**, it is considered as sensor wire break.

Wire break alarm lowest limit: Feedback signal is under alarm upper limit for time **[Fb.14]**, it is considered as sensor wire break.

Fb.18	Stable pressure water-supplying dormancy system selections	Setting range: 0-1	Factory set: 0
Fb.19	Start-up value	Setting range: 0.0-100.0%	Factory set: 0.0%
Fb.20	Dormancy detection value coefficient	Setting range: 0.0-1.000	Factory set: 0.900
Fb.21	Dormancy detection DEC time	Setting range: 0.0-6500.0s	Factory set: 30.0s
Fb.22	Dormancy detection low point hold frequency	Setting range: 0.00-20.00Hz	Factory set: 10.00Hz

Stable pressure water-supplying dormancy system selections: It sets whether use dormancy system while PID for stable pressure water-supplying. While use, inverter start dormancy detection if PID feedback higher or equal to PID setting for a certain time. In dormancy detection process, if feedback is bigger than detection value, inverter reduces output frequency to [Fb.22] for a while. If PID feedback is still higher than detection value, inverter reduces output frequency to 0.00Hz, enter to dormancy state. In this process, if feedback is lower than detection value, dormancy detection is invalid. Inverter is back to PID adjustment state.

0: Invalid

1: Valid

Start-up value: While inverter enters dormancy system, PID feedback must be lower than start-up value. Otherwise inverter can not start. If start-up value is too high, it maybe causes inverter frequency start and stop. But if it is too low, it maybe causes under-pressure. It is defined as ratio of PID feedback to sensor max measuring range.

Dormancy detection value coefficient: In process that inverter enters dormancy system in mode of reducing output frequency, once PID feedback is lower dormancy detection value, inverter back to PID adjustment state. If it set as 1.000, system takes PID setting as exit value in frequency reduce state. Dormancy detection value is defined as the result of this value multiples PID given.

Dormancy detection DEC time: Set DEC time for inverter reducing frequency in dormancy detection process.

Dormancy detection low point hold frequency: Set frequency that inverter holds at the low point in dormancy detection process.

9.14 Multistep, PLC function and swing frequency parameters

FC.00	Step 1	Setting range: 0.00-320.00Hz	Factory set: 10.00Hz
FC.01	Step 2	Setting range: 0.00-320.00Hz	Factory set: 20.00 Hz
FC.02	Step 3	Setting range: 0.00-320.00Hz	Factory set: 30.00 Hz
FC.03	Step 4	Setting range: 0.00-320.00Hz	Factory set: 40.00 Hz
FC.04	Step 5	Setting range: 0.00-320.00Hz	Factory set: 50.00 Hz
FC.05	Step 6	Setting range: 0.00-320.00Hz	Factory set: 40.00 Hz
FC.06	Step 7	Setting range: 0.00-320.00Hz	Factory set: 30.00 Hz
FC.07	Step 8	Setting range: 0.00-320.00Hz	Factory set: 20.00 Hz
FC.08	Step 9	Setting range: 0.00-320.00Hz	Factory set: 10.00 Hz
FC.09	Step 10	Setting range: 0.00-320.00Hz	Factory set: 20.00 Hz
FC.10	Step 11	Setting range: 0.00-320.00Hz	Factory set: 30.00 Hz
FC.11	Step 12	Setting range: 0.00-320.00Hz	Factory set: 40.00 Hz
FC.12	Step 13	Setting range: 0.00-320.00Hz	Factory set: 50.00 Hz
FC.13	Step 14	Setting range: 0.00-320.00Hz	Factory set: 40.00 Hz
FC.14	Step 15	Setting range: 0.00-320.00Hz	Factory set: 30.00 Hz

It sets run frequency of 15 steps in PLC and multistep control.

Mult steps control has priority only after JOG. While multi steps control, 4 multifunction input terminals are needed to set as control terminals. Set details refer to [F2.00-F2.07].

Inverter is running at which step is decided by the ON/OFF state of 4 control terminal and **COM**. Run and direction is controlled by run signal and direction given by [F0.02]. ACC/DEC time default is ACC/DEC time 1 [F0.14], [F0.15]. Or select ACC/DEC time by ACC/DEC time selection terminal set by [F2.00-F2.07].

Multi steps terminal 4	Multi steps terminal 3	Multi steps terminal 2	Multi steps terminal 1	terminal speed
OFF	OFF	OFF	ON	1X [FC.00]
OFF	OFF	ON	OFF	2X [FC.01]
OFF	OFF	ON	ON	3X [FC.02]
OFF	ON	OFF	OFF	4X [FC.03]
OFF	ON	OFF	ON	5X [FC.04]
OFF	ON	ON	OFF	6X [FC.05]
OFF	ON	ON	ON	7X [FC.06]
ON	OFF	OFF	OFF	8X [FC.07]
ON	OFF	OFF	ON	9X [FC.08]
ON	OFF	ON	OFF	10X [FC.09]
ON	OFF	ON	ON	11X [FC.10]
ON	ON	OFF	OFF	12X [FC.11]
ON	ON	OFF	ON	13X [FC.12]
ON	ON	ON	OFF	14X [FC.13]
ON	ON	ON	ON	15X [FC.14]

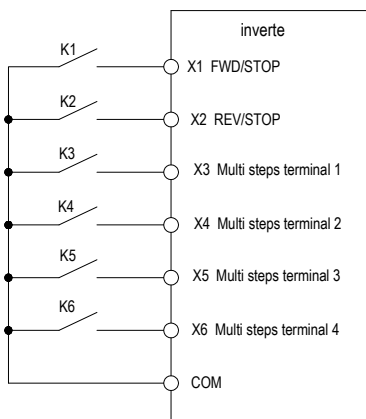

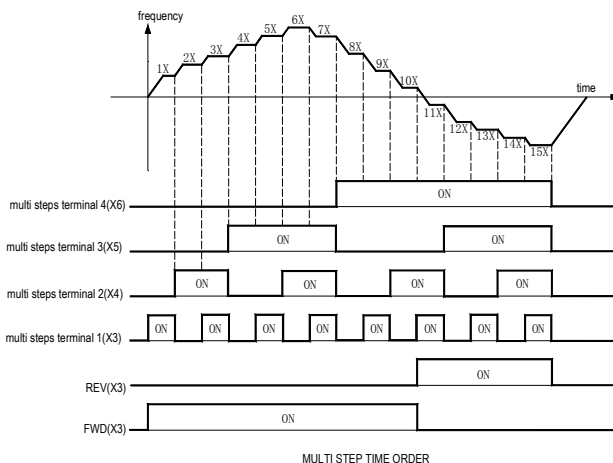

FC.15	PLC run mode selections	Setting range: 0000-2212	Factory set: 0000
-------	-------------------------	--------------------------	-------------------

LED "0" digit: cycle mode

0: Stop after single cycle While receiving order, inverter run from the first step, time unit is set by [FC.15] LED "00" digit. Running time is set by [FC.16-FC.30]. Running direction and ACC/DEC time is selected by [FC.31-FC.45]. Turn to next step while run time is over, run time, direction, ACC/DEC time of every step can be set separately. Inverter output 0 Hz while finished 15 steps running. If one step running time is 0, it will skip this step.

1: Continuous cycles Inverter not stop and runs at the latest speed while finished 15 steps running. Time unit is set by [FC.15] LED "00" digit. Run time is set by [FC.16-FC.30]. Run direction and ACC/DEC time is selected by [FC.31-FC.45].

2: Keep final value after single cycle Inverter back to 1st step while finished 15 steps running. Time unit is set by [FC.15] LED "00" digit. Run time is set by [FC.16-FC.30]. Run direction and ACC/DEC time is selected by [FC.31-FC.45]

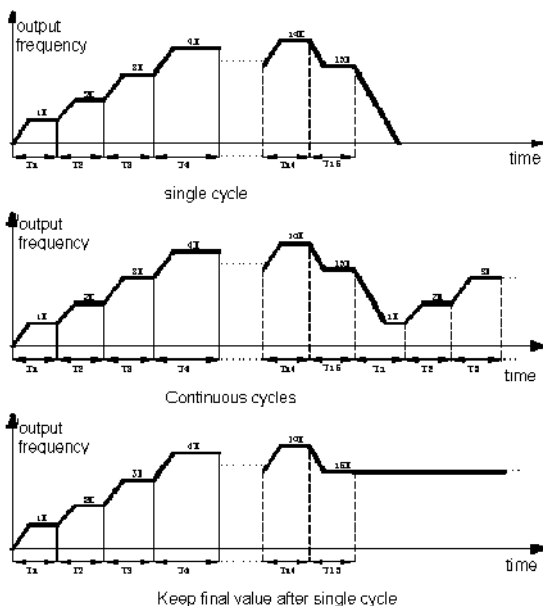

LED“00”digit: Time unit

0: second

1: minute

2: hour

LED“000”digit: Power down save mode

0: no save

1: save

Decide whether save running state while power down. If save, define recover mode by [FC.15] LED “0000” digit. If need continue the state before power off, this parameter should be set as 1.

LED“0000”digit: Start-up mode

0: Restart from the 1st step

1: Restart from the step where stop

2: Restart from the time when stop

Set restart mode while stop for some reasons (stop, fault, power off and so on).

Output frequency is limited by upper/lowest limitation. While frequency is lower then lowest limitation, it runs as [F0.13] lowest limitation mode.

FC.16	PLC 1st step running time	Setting range: 0.0-6500.0(s/m/h)	Factory set: 10.0
FC.17	PLC 2nd step running time	Setting range: 0.0-6500.0(s/m/h)	Factory set: 10.0
FC.18	PLC 3rd step running time	Setting range: 0.0-6500.0(s/m/h)	Factory set: 10.0
FC.19	PLC 4th step running time	Setting range: 0.0-6500.0(s/m/h)	Factory set: 10.0
FC.20	PLC 5th step running time	Setting range: 0.0-6500.0(s/m/h)	Factory set: 10.0
FC.21	PLC 6th step running time	Setting range: 0.0-6500.0(s/m/h)	Factory set: 10.0
FC.22	PLC 7th step running time	Setting range: 0.0-6500.0(s/m/h)	Factory set: 10.0
FC.23	PLC 8th step running time	Setting range: 0.0-6500.0(s/m/h)	Factory set: 10.0

FC.24	PLC 9th step running time	Setting range: 0.0-6500.0(s/m/h)	Factory set: 10.0
FC.25	PLC 10th step running time	Setting range: 0.0-6500.0(s/m/h)	Factory set: 10.0
FC.26	PLC 11th step running time	Setting range: 0.0-6500.0(s/m/h)	Factory set: 10.0
FC.27	PLC 12th step running time	Setting range: 0.0-6500.0(s/m/h)	Factory set: 10.0
FC.28	PLC 13th step running time	Setting range: 0.0-6500.0(s/m/h)	Factory set: 10.0
FC.29	PLC 14th step running time	Setting range: 0.0-6500.0(s/m/h)	Factory set: 10.0
FC.30	PLC 15th step running time	Setting range: 0.0-6500.0(s/m/h)	Factory set: 10.0

Set running time of every 15 step. Time unit is decided by **[FC.15]** LED "00" digit setting.

FC.31	PLC 1st step direction and ADD/DEC time	Setting range:0000-0031	Factory set: 0000
FC.32	PLC 2nd step direction and ADD/DEC time		Factory set: 0000
FC.33	PLC 3rd step direction and ADD/DEC time		Factory set: 0000
FC.34	PLC 4th step direction and ADD/DEC time		Factory set: 0000
FC.35	PLC 5th step direction and ADD/DEC time		Factory set: 0000
FC.36	PLC 6th step direction and ADD/DEC time		Factory set: 0000
FC.37	PLC 7th step direction and ADD/DEC time		Factory set: 0000
FC.38	PLC 8th step direction and ADD/DEC time		Factory set: 0000
FC.39	PLC 9th step direction and ADD/DEC time		Factory set: 0000
FC.40	PLC 10th step direction and ADD/DEC time		Factory set: 0000
FC.41	PLC 11th step direction and ADD/DEC time		Factory set: 0000
FC.42	PLC 12th step direction and ADD/DEC time		Factory set: 0000
FC.43	PLC 13th step direction and ADD/DEC time		Factory set: 0000
FC.44	PLC 14th step direction and ADD/DEC time		Factory set: 0000
FC.45	PLC 15th step direction and ADD/DEC time		Factory set: 0000

Set running direction and ACC/DEC time of every 15 step while running.

LED "0" digit: this step run direction

0: REV

1: REV

If **[F0.07]** LED "00" digit is 0 or **[F0.16]** is 2, and this setting is 1 REV, inverter runs as 0.00Hz.

LED "00" digit: ACC/DEC time in this step

0: ACC/DEC time 1

1: ACC/DEC time 2

2: ACC/DEC time 3

4: ACC/DEC time 4

LED "000" digit: reserved

LED "0000" digit: reserved

FC.46-FC.48	Reserved
-------------	----------

FC.49	Swing frequency control	Setting range: 0000-0111	Factory set: 0000
FC50	Swing frequency pre-set	Setting range: 0.00-max frequency	Factory set: 0.00Hz
FC.51	Pre-set frequency hold time	Setting range: 0.00-650.00s	Factory set: 0.00s
FC.52	AW	Setting range: 0.0-100.0%	Factory set: 0.0%

FC.53	Jumping frequency amplitude	Setting range: 0.0-50.0%	Factory set: 0.0%
FC.54	Swing frequency ACC time	Setting range: 0.00-650.00s	Factory set: 5.00s
FC.55	Swing frequency DEC time	Setting range: 0.00-650.00s	Factory set: 5.00s

Swing frequency control process: ACC according ACC time to [FC.49] and wait time [FC.50], run to swing centre frequency according ACC/DEC time, then run cycle as setting of [FC.51],[FC.52],[FC.53] and [FC.54],DEC to stop according ACC/DEC time while receiving stop order.

LED "0" digit: swing frequency control

0: invalid

1: valid

LED "00" digit: swing frequency get in mode

0: automatic Run as frequency [FC.49] for time [FC.50] after start, and entry swing frequency running.

1: manual Run as frequency [FC.49] after start, and entry swing frequency running while multi function input terminal is valid. Exit and run as frequency [FC.49] while it is invalid.

LED "000" digit: AW control

0: variable AW is variable according the centre frequency.

1: fixed AW is decided by max frequency and [FC.51].

LED "0000" digit: reserved

Jumping frequency amplitude: Set jumping frequency in swing frequency running.

$$\text{Jumping frequency} = \text{AW} \times [\text{FC.51}]$$

Swing frequency pre-set: Set frequency before swing frequency running.

Pre-set frequency hold time: While [FC.48] LED "00" digit is 0, it used to set the pre-set frequency holding time before swing frequency running. While manual swing frequency get in, it is invalid.

AW: Set frequency swing amplitude while swing frequency control.

$$\text{Variable AW: AW} = \text{centre frequency} \times [\text{FC.51}]$$

$$\text{Fixed AW: AW} = \text{max frequency} [\text{F0.09}] \times [\text{FC.51}]$$

Swing frequency ACC time:

Swing frequency DEC time:

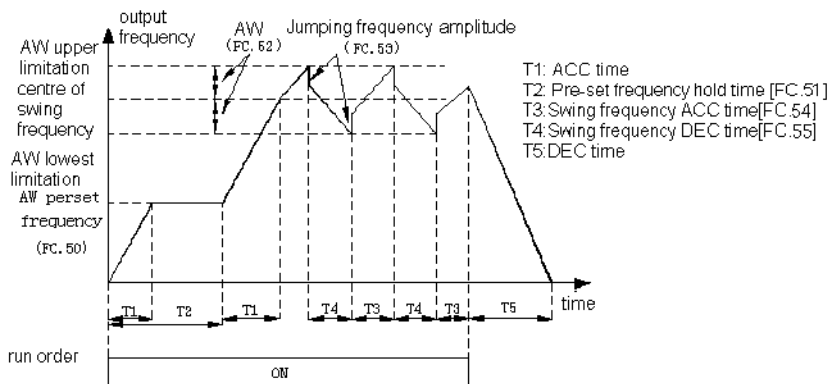

SWING FREQUENCY RUNNING

9.15 Communication control function parameters

Fd.00	Main-slave machine	Setting range: 0-1	Factory set: 0
-------	--------------------	--------------------	----------------

Take inverter as main machine or slave machine while Modbus communication. Details for Modbus refer to Appendix 2:RS485 communication protocol.

0: Slave machine Inverter is slave machine. Communication address is decided by [Fd.01]. Inverter accepts order from main machine and reply or not while writing operation according [Fd.08] setting. Reply delay time is set by [Fd.05].

1: Main machine Inverter, as main machine, sends data to communication net by broadcast orders. All slave machines accept orders from main machine. Main machine sending data is set by [Fd.09].

Fd.01	Machine add	Setting range: 1-247	Factory set: 1
-------	-------------	----------------------	----------------

It set communication address while inverter is slave machine. If inverter is main machine, this parameter is no meaning. 0 is broadcast address.

Fd.02	Communication baud rate selections	Setting range: 0-5	Factory set: 3
-------	------------------------------------	--------------------	----------------

- 0:1200 bps
- 1:2400 bps
- 2:4800 bps
- 3:9600 bps
- 4:19200 bps
- 5:38400 bps

Fd.03	Data format	Setting range: 0-5	Factory set: 0
-------	-------------	--------------------	----------------

- 0: (N, 8, 1) no checkout, Data digit: 8, Stop digit: 1
- 1: (E, 8, 1) even checkout, Data digit: 8, Stop digit: 1
- 2: (O, 8, 1) odd checkout, Data digit: 8, Stop digit: 1
- 3:(N,8,2) no checkout,Data digit:8, Stop digit:2
- 4:(E,8,2) even checkout,Data digit:8, Stop digit:2
- 5:(O,8,2) odd checkout,Data digit:8, Stop digit:2

Fd.04	Communication ratio setting	Setting range: 0.00-5.00	Factory set: 1.00
-------	-----------------------------	--------------------------	-------------------

The result of upper machine multiply this parameter is communication giving or feedback of this machine. Upper machine communication order can be modified pro rate.

Fd.05	Communication answer delay	Setting range: 0-500ms	Factory set: 0ms
-------	----------------------------	------------------------	------------------

While delay time is shorter than system dealing time, real delay time is same as system dealing time. While delay time is longer than system dealing time, it has to delay while system dealing finished. It does not send data to upper machine until delay time arrive.

Fd.06	Communication overtime fault time	Setting range: 0.1-100.0s	Factory set: 1.0s
Fd.07	RS485 communication fault act mode selections	Setting range: 0-2	Factory set: 1

Communication overtime fault time: If the interval between one communication and next communication is over communication overtime, it is considered as communication break fault. **[Fd.07]** decides the act mode.

RS485 communication fault act mode selections

0: Alarm and stop freely If it has not received next frame order or ther communication order while the latest communication giving order is over **[Fd.06]** time setting, inverter alarms fault E.CE and stops.

1: Not alarm, go on run Inverter does not inspect fault and always runs according the latest order.

2: Stop without alarm If it has not received next frame order or ther communication order while the latest Communication giving order is over **[Fd.06]** time setting.inverter will clear orders before and back to standby state.

Fd.08	Transmission response	Setting range:0-1	Factory set: 0
-------	-----------------------	-------------------	----------------

It decides whether inverter responds while upper machine send write order.

0: write operation with response

1: write operation without response

Fd.09	Main machine sending selections	Setting range: 0000-AAAA	Factory set: 0031
-------	---------------------------------	--------------------------	-------------------

Set the data that inverter sends the slave machines while inverter is main machine.

LED "0" digit: 1st group of frame selection

0: invalid

1: run order give

2: main machine give frequency

3: main machine output frequency

4: main machine max frequency

5: Reserved

6: main machine output torque

7: Reserved

8: Reserved

9: main machine give PID

A: main machine feedback PID

LED "00" digit: 2nd group of frame selection

LED "000" digit: 3rd group of frame selection

LED "0000" digit: 4th group of frame selection

Chapter 10 Appendix

“●”: Parameter can be changed in the running state.

“○”: Parameter can't be changed in the running state.

“×”: Parameter can be read only.

“-”: Factory setting parameter, only factory can set.

“※”: Parameter is related to the model.

Basic parameters

NO.	Function description	Range of settings and definition	Factory setting	Attribute	Reference page	Communication add
F0.00	Control way	0: VC without PG 1: V/F without PG 2: VC with PG 3: V/F with PG	0	○	71	0x000
F0.01	Control mode	0: Speed mode 1: Torque mode	1	○	71	0x001
F0.02	Run command channel	0: Keyboard control 1: Terminal control 2: RS485 communication control 3: Optional card	0	○	73	0x002
F0.03	Frequency given main channel selection	0: Keyboard number given 1: Keyboard potentiometer given 2: Terminal VS1 voltage analog given 3: Terminal VS2 voltage analog given 4: Terminal AS current analog given 5: Terminal pulse signal given 6: RS485 communication port given 7: Ascend, descent control given 8: PID control given 9: Program control given 10: Reserved 11: Optional card given 12: Terminal selection	0	○	74	0x003
F0.04	Main channel gain	0.000-5.000	1.000	○	75	0x004
F0.05	Frequency given auxiliary channel selection	0: Keyboard digital given 1: Keyboard potentiometer given 2: Terminal VS1 voltage analog given 3: Terminal VS2 voltage analog given 4: Terminal AS current analog given 5: Terminal pulse signal given 6: RS485 communication port given	1	○	75	0x005
F0.06	Auxiliary channel gain	0.000-5.000	1.000	○	76	0x006

F0.07	Frequency given channels combination mode	LED"0"digit: 0: Main channel valid 1: Auxiliary channel valid 2: Main + auxiliary 3: Main-auxiliary 4: MAX{ main, auxiliary } 5: MIN{ main, auxiliary } 6: Main*auxiliary LED"10"digit: 0: Direction of frequency control is invalid 1: Direction of frequency control is invalid LED"100"digit: Reserved LED"1000"digit: Reserved	0000	○	76	0x007
F0.08	Keyboard number setting frequency	0-upper limit	50.00 Hz	●	77	0x008
F0.09	Max frequency output	0-320.00Hz	50.00 Hz	○	77	0x009
F0.10	Upper limitation source selection	0: Upper limit frequency digital given 1: Keyboard potentiometer given 2: Terminal VS1 voltage analog given 3: Terminal VS2 voltage analog given 4: Terminal AS current analog given 5: Terminal pulse signal 6: RS485 communication given	0	○	77	0x00A
F0.11	Upper limit frequency digital setting	Lower limit-max output frequency	50.00 Hz	○	77	0x00B
F0.12	low limit frequency	0-upper limit	0.00	○	77	0x00C
F0.13	low limit frequency running mode	0: Stop 1: Run as lower frequency limitation	1	○	77	0x00D
F0.14	ACC time 1	0.01-650.00s	Accord model	●	78	0x00E
F0.15	DEC time 1	0.01-650.00s	Accord model	●	78	0x00F
F0.16	Rotate direction	0: Consistent 1: Reverse 2: Reverse banned	0	●	79	0x010
F0.17	Carrier frequency	0.6-15.0kHz	Accord model	●	79	0x011

F0.18	Carrier frequency characteristic selection	LED"0"digit: 0: Related to temperature 1: Unrelated to temperature LED"10"digit: 0: Related to frequency output 1: Unrelated to frequency output LED"100"digit: 0: Fixed carrier 1: Random carrier LED"1000"digit: PWM send wave mode 0: PWM mode 1 1: PWM mode 2 2: PWM mode 3	0000	●	79	0x012
F0.19	Parameter initialization	0: Not action 1: Recover factory setting 2: Clear malfunction records	0	○	80	0x013
F0.20	AVR function selection	0: invalid 1: all valid 2: valid in DEC only	2	●	80	0x014

Run control parameters

NO.	Function description	Range of settings and definition	Factory setting	Attribute	Reference page	Communication add
F1.00	Start-up mode running	0: Start directly 1: Braking first then start by start frequency 2: Speed tracking , judge direction then start	0	○	80	0x100
F1.01	Start pre-excitation time	0.00-60.00s	Accord model	●	80	0x101
F1.02	Start frequency	0.00-60.00Hz	0.50Hz	●	80	0x102
F1.03	Start frequency hold time	0.0-50.0s	0.0s	●	80	0x103
F1.04	Braking current before starting	0-150.0%	0.0%	●	80	0x104
F1.05	Braking time before starting	0.0-30.0s	0.0s	●	80	0x105
F1.06	Speed tracking stability waiting time	0.00-60.00s	Accord model	●	81	0x106
F1.07	Stop mode	0: DEC to stop 1: Free stop	0	●	81	0x107
F1.08	DC braking initial frequency	0.00-50.00Hz	0.00Hz	●	82	0x108
F1.09	DC braking current	0.0-150.0%	0.0%	●	82	0x109

F1.10	DC braking waiting time	0.0-60.0s	0.0s	●	82	0x10A
F1.11	DC braking duration	0.0-60.0s	0.0s	●	82	0x10B
F1.12	Reserved				82	0x10C
F1.13	ACC/DEC mode selection	ACC/DEC mode selections 0: max frequency 1: fixed frequency LED "00" digit: ACC/DEC mode 0: Beeline 1: S Curve LED "000" digit: reserved LED "0000" digit: reserved	0000	○	82	0x10D
F1.14	Start ACC rate of S curve	20.0%-100.0%	50.0%	●	82	0x10E
F1.15	ACC slope increment of S curve	0.0-500.0%	50.0%	●	82	0x10F
F1.16	Reserved				83	0x110
F1.17	Reserved				83	0x111
F1.18	ACC time 2	0.00-650.00s	10.00s	●	83	0x112
F1.19	DEC time 2	0.00-650.00s	10.00s	●	83	0x113
F1.20	ACC time 3	0.00-650.00s	10.00s	●	83	0x114
F1.21	DEC time 3	0.00-650.00s	10.00s	●	83	0x115
F1.22	ACC time 4	0.00-650.00s	10.00s	●	83	0x116
F1.23	DEC time 4	0.00-650.00s	10.00s	●	83	0x117
F1.24	Emergency stop DEC time	0.01-650.00s	10.00s	●	83	0x118
F1.25	FWD&REV dead time	0.0-120.0s	0.0s	●	84	0x119
F1.26	Min output frequency	0.00-60.00Hz	0.50Hz	●	84	0x11A
F1.27	0 speed hold torque	0.0-150.0%	Accord model	●	84	0x11B
F1.28	0 speed torque keep time	0.0-500.0s	5.0s	●	84	0x11C
F1.29	Power off restart action selection	0: Invalid 1: Valid	0	●	84	0x11D
F1.30	Power off restart waiting time	0.00-650.00s	0.50s	●	84	0x11E

F1.31	Terminal running protection selection	LED "0" digit: run command selection while electrify 0: Terminal running order invalid while electrify 1: Terminal running order valid while electrify LED "10" digit: while switch the run command given channel 0: invalid 1: valid	0011	●	85	0x11F
F1.32	JOG running frequency setting	0.00-Max frequency	5.00Hz	●	85	0x120
F1.33	JOG ACC time	0.00-650.00s	10.00s	●	85	0x121
F1.34	JOG DEC time	0.00-650.00s	10.00s	●	85	0x122
F1.35	Jump frequency	0.00-Max frequency	0.00Hz	●	85	0x123
F1.36	Jump frequency range	0.00-Max frequency	0.00Hz	●	85	0x124

Quantum digital terminal functions

NO.	Function description	Range of settings and definition	Factory setting	Attribute	Reference page	Communication add
F2.00	Multifunction input terminal 1(X1)	0: No function 1: FWD 2: REV 3: 3-line running control 4: FWD JOG 5: REV JOG	1	●	86	0x200
F2.01	Multifunction input terminal 2(X2)	6: Free stop 7: Emergency stop 8: Malfunction reset 9: Exterior fault input 10: Frequency UP 11: Frequency DW 12: UP/DW clear 13: Reserved 14: Reserved	2	●	86	0x201
F2.02	Multifunction input terminal 3(X3)	15: Multistep terminal 1 16: Multistep terminal 2 17: Multistep terminal 3 18: Multistep terminal 4	4	●	86	0x202
F2.03	Multifunction input terminal 4(X4)	19: ACC/DEC time choose terminal 1 20: ACC/DEC time choose terminal 2 21: ACC/DEC pause 22: PID control cancel 23: PID control pause 24: PID characteristic switch	5	●	86	0x203

F2.04	Multifunction input terminal 5(X5)	25: PID given switch 1 26: PID given switch 2 27: PID given switch 3 28: PID feedback switch 1	6	●	86	0x204
F2.05	Multifunction input terminal 6(X6)	29: PID feedback switch 2 30: PID feedback switch 3 31: PLC pause 32: PLC restart 33: Swing frequency into 34: Swing frequency pause	8	●	86	0x205
F2.06	Multifunction input terminal 7(X7)	35: Swing frequency reset 36: Frequency channel change terminal 1	56	●	86	0x206
F2.07	Multifunction input terminal 8(X8)	37: Frequency channel change terminal 2 38: Frequency channel change terminal 3 39: Frequency channel change terminal 4 40: Timer trigger terminal 41: Timer clear zero terminal 42: Timer clock input terminal 43: Counter clear terminal 44: DC braking order 45: Pre excitation order terminals 46: Reserved 47: Start magnetic particle clutch function 48: PID parameter switch terminal 1 49: PID parameter switch terminal 2 50: Initial roll diameter setting terminal 1 51: Initial roll diameter setting terminal 2 52: Linear speed selection terminal 53: Material thickness selection terminal 54: Full roll diameter selection terminal 55: Empty to full roll time selection terminal 56: Roll diameter reset terminal 57: Roll diameter calculation pause	57	●	86	0x207

F2.08	X1-X4 terminal trait selection	LED "0" digit: X1 terminal 0: On valid 1: Off valid LED "00" digit: X2 terminal 0: On valid 1: Off valid LED "000" digit: X3 terminal 0: On valid 1: Off valid LED "0000" digit: X4terminal 0: On valid 1: Off valid	0000	●	90	0x208
F2.09	X1-X4 input terminal filer time	0.000-60.000s	0.010s	●	90	0x209
F2.10	X5-X8 terminal trait selection	LED "0" digit: X5 terminal 0: On valid 1: Off valid LED "00" digit: X6 terminal 0: On valid 1: Off valid LED "000" digit: X7 terminal 0: On valid 1: Off valid LED "0000" digit: X8 terminal 0: On valid 1: Off valid	0000	●	90	0x20A
F2.11	X5-X8 input terminal filer time	0.000-60.000s	0.010s	●	90	0x20B
F2.12	Terminal control mode	0: 2-line 1 1: 2-line 2 2: 3-line 1 3: 3-line 2	0	○	90	0x20C

F2.13	Terminal action mode	LED "0" digit: free stop terminal reset mode 0: Reset to original order while invalid 1: Not reset to original order while invalid LED "00" digit: emergency stop terminal reset mode 0: Reset to original order while disconnect 1: Not reset to original order while disconnect LED "000" digit: terminal run mode after fault reset 0: Terminal control to power on directly 1: Terminal control to power on after stop LED "0000" digit: reserved	0111	●	91	0x20D
F2.14	Reserved				92	0x20E
F2.15	Reserved				92	0x20F
F2.16	PUL input min frequency	0.0-50.00kHz	0.00kHz	●	92	0x210
F2.17	PUL min frequency corresponding setting	0.00-100.00%	0.00%	●	92	0x211
F2.18	PUL input max frequency	0.0-50.00kHz	50.00 kHz	●	92	0x212
F2.19	PUL max frequency corresponding setting	0-100.00%	100.00%	●	92	0x213
F2.20	PUL filter time	0.00s-10.00s	0.10s	●	92	0x214
F2.21	PUL cut-off frequency	0.000-50.000kHz	0.010 kHz	●	92	0x215
F2.22	UP/DW terminal frequency adjust selection	0:Off electricity storage 1:Off electricity does not storage 2:Valid in running, clear zero at stop	0	●	92	0x216
F2.23	UP/DW terminal frequency add/dec speed time	0.01-50.00Hz/s	0.50Hz/s	●	92	0x217
F2.24	Reserved				93	0x218
F2.25	Timer time of unit	0: Second 1: Minute 2: Hour	0	●	93	0x219
F2.26	Timer setting	0-65000	0	●	93	0x21A
F2.27	Counter max value	0-65000	1000	●	93	0x21B

F2.28	Counter setting value	0-65000	500	●	93	0x21C
F2.29	Output terminal 1 (Y1)	0: No output 1: Running 2: REV 3: Fault trip alarm 1(alarm while fault self-recover) 4: Fault trip alarm 2(no alarm while fault self-recover) 5: Fault retry	1	●	93	0x21D
F2.30	Output terminal 2 (Y2)	6: Out fault stop 7: Under voltage 8: Finish ready for running 9: Output frequency level test 1(FDT1) 10: Output frequency level test 2(FDT2) 11: Frequency arrive 12: running at 0 speed 13: Upper frequency limit arrive 14: Lower frequency limit arrive	2	●	93	0x21E
F2.31	Relay output terminal (TA-TB-TC)	15: Program running circle period finished 16: Program running step finished 17: PID feedback exceed upper limit 18: PID feedback under lower limit 19: PID feedback sensor wire break 20: Reserved 21: Timer time arrive 22: Counter arrive biggest value 23: Counter arrive setting 24: Energy braking 25: PG feedback break 26: Emergency stop 27: Pre alarm output for over load 28: Pre alarm output for under load 29: Roll diameter arrive output	3	●	93	0x21F
F2.32	Output frequency level 1 (FDT1)	0.00-Max frequency	30.00Hz	●	94	0x220
F2.33	FDT1 lag	0.00-Max frequency	0.00Hz	●	94	0x221
F2.34	Output frequency level 2 (FDT2)	0.00-Max frequency	50.00Hz	●	94	0x222
F2.35	FDT2 lag	0.00-Max frequency	0.00Hz	●	94	0x223
F2.36	Speed arriving checkout range	0.00-Max frequency	0.00Hz	●	95	0x224
F2.37	Over load per alarm level	0.0-200.0%	180.0%	●	95	0x225

F2.38	Over load per alarm delay	0.0-100.0s	0.5s	●	95	0x226
F2.39	Under load pre alarm level	0.0-200.0%	30.0%	●	95	0x227
F2.40	Under load pre alarm delay	0.0-100.0s	0.5s	●	95	0x228

Modulus terminal functions

NO.	Function description	Range of settings and definition	Factory setting	Attribute	Reference page	Communication add
F3.00	VS1 Lowest limit	0.00V-10.00V	0.00V	●	96	0x300
F3.01	VS1 Lowest limit corresponding setting	0.00-100.00%	0.00%	●	96	0x301
F3.02	VS1 upper limit	0.00V-10.00V	10.00V	●	96	0x302
F3.03	VS1 upper limit corresponding setting	0.00-100.00%	100.00%	●	96	0x303
F3.04	VS1 filter time	0.00s-10.00s	0.10s	●	96	0x304
F3.05	VS2 Lowest limit	0.00V-10.00V	0.00V	●	96	0x305
F3.06	VS2 Lowest limit corresponding setting	0.00-100.00%	0.00%	●	96	0x306
F3.07	VS2 upper limit	0.00V-10.00V	10.00V	●	96	0x307
F3.08	VS2 upper limit corresponding setting	0.00-100.00%	100.00%	●	97	0x308
F3.09	VS2 filter time	0.00s-10.00s	0.10s	●	97	0x309
F3.10	AS Lowest limit	0.00-20.00mA	4.00mA	●	97	0x30A
F3.11	AS Lowest limit corresponding setting	0.00-100.00%	0.00%	●	97	0x30B
F3.12	AS upper limit	0.00-20.00mA	20.00mA	●	97	0x30C
F3.13	AS upper limit corresponding setting	0-100.00%	100.00%	●	97	0x30D
F3.14	AS filter time	0.00s-10.00s	0.10s	●	97	0x30E
F3.15	Reserved			○	97	0x30F
F3.16	Reserved			○	97	0x310
F3.17	Reserved			○	97	0x311
F3.18	Reserved			○	97	0x312
F3.19	Reserved			○	97	0x313
F3.20	Reserved			○	97	0x314
F3.21	Reserved			○	97	0x315

F3.22	A01 output selection	0: Set frequency 1: running frequency 2: Output current 3: Input voltage 4: Output voltage 5: Run speed 6: Set torque 7: Output torque 8: PID give 9: PID feedback	0	●	97	0x316
F3.23	A02 output selection	10: Set tension 11: Bus voltage 12: Current roll diameter 13: VS2 input 14: Time per roll 15: Reserved 16: VS1 input 17: VS2 input 18: AS input 19: PUL input	1	●	97	0x317
F3.24	A01 output gain	25.0~200.0%	100.0%	●	98	0x318
F3.25	A01 output signal bias	-10.0~10.0%	0.0%	●	98	0x319
F3.26	A02 signal selection	0: 0-10V 1: 4.00-20.00mA 2: 0.00-20.00mA 3: Frequency pulse output	0	●	99	0x31A
F3.27	A02 output gain	25.0~200.0%	100.0%	●	99	0x31B
F3.28	A02 output signal bias	-10.0~10.0%	0.0%	●	99	0x31C
F3.29	A02FM frequency output lower limit	0.00k-50.00kHz	0.20kHz	●	99	0x31D
F3.30	A02FM frequency output upper limit	0.00k-50.00kHz	50.00 kHz	●	99	0x31E

Keyboard and display parameters

NO.	Function description	Range of settings and definition	Factory setting	Attribute	Reference page	Communication add
F4.00	Parameter and key lock selections	0: Unlock 1: Function parameter lock 2: Function parameter and key lock (except for RUN/STOP/JOG) 3: All function parameter and key lock	0	●	100	0x400
F4.01	User password	0-9999	0	●	100	0x401

F4.02	REV/JOG selections	0: REV 1: JOG	0	●	100	0x402
F4.03	STOP key function range	LED "0" digit: terminal control 0: invalid to terminal order 1: valid to terminal order LED "00" digit: communication control 0: invalid to communication order 1: valid to communication order LED "000" digit: reserved LED "0000" digit: reserved	0000	●	100	0x403
F4.04	UP/DOWN key modification selections	LED "0" digit: keyboard UN/DOWN key modify selection 0: Invalid 1: Modify frequency setting by keyboard numbers (F0.08) 2: Reserved 3: Modify PID give setting by keyboard numbers (Fb.01) 4: Reserved LED "00" digit: keyboard UN/DOWN key store selection 0: No save after power down 1: Save after power down LED "000" digit: reserved LED "0000" digit: reserved	0011	●	101	0x404
F4.05	Function parameter copy	0: No operation 1: Send machine parameters to keyboard and save 2: Send parameters to keyboard and save	0	○	101	0x405
F4.06	Reserved				101	0x406
F4.07	Keyboard potentiometer lowest limit	0.00V-5.00V	0.50V	●	101	0x407
F4.08	Keyboard potentiometer lowest limit corresponding setting	0-100.00%	0.00%	●	101	0x408
F4.09	Keyboard potentiometer upper limit	0.00V-5.00V	4.50V	●	101	0x409
F4.10	Keyboard potentiometer upper limit corresponding setting	0-100.00%	100.00%	●	101	0x40A

F4.11	The display content of the first line at the running state	<p>LED"0"digit: display the first group 0: Given frequency 1: Output frequency 2: Output current 3: Input voltage 4: Output voltage 5: Machine speed 6: Reserved 7: Output torque 8: PID given value 9: PID feedback value A: Output power B: Bus voltage C: Module temperature 1 D: Module temperature 2 E: ON/OFF state of input terminal X F: ON/OFF state of input terminal Y</p> <p>LED"10"digit: display the second group LED"100"digit: display the third group LED"1000" digit: display the fourth group</p>	3210	●	102	0x40B
F4.12	The display content of the first line at the stopped state	<p>LED "0" digit: display the first group LED"00"digit:display the second group LED"000" digit: display the third group LED"0000"digit:display the fourth group</p>	3210	●	102	0x40C
F4.13	The display content of the second line at the running state	<p>LED "0" digit: display the first group LED"00"digit:display the second group LED"000" digit: display the third group LED"0000"digit:display the fourth group</p>	3210	●	102	0x40D
F4.14	The display content of the second line at the stopped state	<p>LED "0" digit: display the first group LED"00"digit:display the second group LED"000" digit: display the third group LED"0000"digit:display the fourth group</p>	3210	●	102	0x40E
F4.15	Rotate speed display coefficient	0.0-5000.0%	100.0%	●	102	0x40F

F4.16	LCD language	LED "0" digit: LED display language 0: Chinese 1: English LED"00" digit: output frequency selection 0: Aim frequency 1: Actual frequency LED"000"digit: machine speed display selection 0: Aim speed 1: Actual speed LED"0000" digit: reserved	0000	●	102	0x410
-------	--------------	---	------	---	-----	-------

Motor parameters

NO.	Function description	Range of settings and definition	Factory setting	Attribute	Reference page	Communication add
F5.00	Reserved			○	103	0x500
F5.01	Number of motor poles	2-48	4	○	103	0x501
F5.02	Motor rated power	0.4-1000.0KW	Accord model	○	103	0x502
F5.03	Motor rated frequency	0.01Hz-max frequency	Accord model	○	103	0x503
F5.04	Motor rated speed	0-65000rpm	Accord model	○	103	0x504
F5.05	Motor rated voltage	0-1500V	Accord model	○	103	0x505
F5.06	Motor rated current	0.1-2000.0A	Accord model	○	103	0x506
F5.07	Motor no-load current	0.01-650.00A	Accord model	●	103	0x507
F5.08	Motor stator resistance	0.001-65.000	Accord model	●	103	0x508
F5.09	Motor rotor resistance	0.001-65.000	Accord model	●	103	0x509
F5.10	Motor stator & rotor inductance	0.1-6500.0mH	Accord model	●	103	0x50A
F5.11	Motor stator & rotor mutual inductance	0.1-6500.0mH	Accord model	●	103	0x50C
F5.12	Motor parameters self-adjustment selections	0: No operation 1: Rotary type self-study 2: Resting type self-study	0	○	103	0x50D
F5.13	Reserved				104	0x50E
F5.14	Reserved				104	0x50F

F5.15	PG selection	LED "0" digit: 0: 1-phase input 1: 2-phase input LED "00" digit: 0: same direction 1: reverse direction LED "000" digit: 0: break inspection OFF 1: break inspection ON LED"0000"digit:PG feedback channel 0: PG port	0001	○	104	0x510
F5.16	Number of pulses per circle	0-60000	1024	○	104	0x511
F5.17	PG break line inspection time	0.100-60.000s	2.000s	●	104	0x512

VC control parameter

NO.	Function description	Range of settings and definition	Factory setting	Attribute	Reference page	Communication add
F6.00	ASR proportional gain 1	0.00-1.00	Accord model	●	105	0x600
F6.01	ASR integral time 1	0.01-10.00s	Accord model	●	105	0x601
F6.02	ASR differential time 1	0.0-100.0	0.0	●	105	0x602
F6.03	ASR filter time1	0.000-0.100s	0.005s	●	105	0x603
F6.04	ASR switch frequency 1	0.0Hz-50.0Hz	5.00Hz	●	105	0x604
F6.05	ASR proportional gain 2	0.00-1.00	Accord model	●	105	0x605
F6.06	ASR integral time 2	0.01-10.00s	Accord model	●	105	0x606
F6.07	ASR differential time 2	0.0-100.0 s	0.0s	●	105	0x607
F6.08	ASR filter time 2	0.000-0.100s	0.001	●	105	0x608
F6.09	ASR switch frequency 2	0.00-50.00Hz	10.0Hz	●	105	0x609
F6.10	VC slip coefficient	10-250%	100%	●	105	0x60A
F6.11	Max output torque	20.0-200.0%	180.0%	●	106	0x60B
F6.12	Constant power area torque compensation start frequency	100.0%-500.0%	120.0%	●	106	0x60C

F6.13	Constant power area torque compensation coefficient	0-100%	30%	●	106	0x60D
F6.14	Constant power area limit start frequency	100.0%-500.0%	200.0%	●	106	0x60E
F6.15	Constant power area limit value	50.0-200%	120%	●	106	0x60F
F6.16	DEC over-excitation selection	0: off 1:on	0	●	106	0x610
F6.17	DEC over-excitation current setting	50.0-200.0%	115.0%	●	106	0x611
F6.18	DEC over-excitation gain	0.00-1.50	Accord model	●	106	0x612

Torque control parameter

NO.	Function description	Range of settings and definition	Factory setting	Attribute	Reference page	Communication add
F7.00	Torque give source selection	LED "0" digit: Main channel selection 0:Keyboard number given torque 1:Keyboard potentiometer given 2: VS1 3: VS2 4: AS 5: PUL 6: RS485 communication give 7: Tension control give LED "00" digit: Second channel selection 0:Keyboard number given torque 1:Keyboard potentiometer given 2: VS1 3: VS2 4: AS 5: PUL 6: RS485 communication give 7: Tension control give LED "000" digit: Main channel add second channel mode 0: Main × [F7.02] 1: Second × [F7.03] 2: Main × [F7.02]+Second × [F7.03] 3: Main × [F7.02] — Second × [F7.03] 4:MAX{main × [F7.02], second × [F7.03]} 5:MIN {main × [F7.02],second × [F7.03]} LED "0000" digit: Reserved	0000	○	107	0x700
F7.01	Keyboard number give torque	0-200.0%	100.0%	●	107	0x701
F7.02	Main torque give channel gain	0-500.0%	100.0%	●	108	0x702

F7.03	Second torque give channel gain	0-500.0%	100.0%	●	108	0x703
F7.04	Reserved				108	0x704
F7.05	Output torque upper limit set selection	0: Keyboard No give. 1: Keyboard potentiometer give 2:VS1 give 3: VS2 give 4: AS give 5:PUL give 6: RS485 give	0	●	108	0x705
F7.06	Output torque upper limit	0.0-200.0%	120.0%	●	108	0x706
F7.07	Output torque lowest limit	0.0-200.0%	1.0%	●	108	0x707
F7.08	Reserved				108	0x708
F7.09	Reserved				108	0x709
F7.10	Zero speed value	0.00~50.00Hz	1.00Hz	●	108	0x70A
F7.11	Zero speed torque gain	0.0~500.0%	100.0%	●	108	0x70B
F7.12	Torque ACC time	0.00-100.00s	0.50	●	108	0x70C
F7.13	Torque DEC time	0.00-100.00s	0.50	●	108	0x70D
F7.14	FWD/REV dead time	0.00-650.00	0.00	●	109	0x70E
F7.15	Static friction compensation	0-200.0%	0	●	109	0x70F
F7.16	Static friction cutoff frequency	0.00-50.00Hz	10.00Hz	●	109	0x710
F7.17	Sliding friction compensation	0-200.0%	0	●	109	0x711
F7.18	Moment of inertia compensation	0-200.0%	0	●	109	0x712
F7.19	Moment of inertia compensation input ACC time	0.0-6000.0s	0	●	109	0x713
F7.20	Moment of inertia compensation input DEC time	0.0-6000.0s	0	●	109	0x714
F7.21	Zero-speed torque keep selection in the torque control mode	LED "0"digit: Zero-speed torque keep set channel 0: Torque setting 1: F1.27 setting LED "00"digit: Zero-speed torque keep time set 0: Zero-speed continue valid 1: Zero-speed valid in F1.28 time LED "000"digit: Reserved LED "00"digit: Reserved	0010	●	110	0x715
F7.22	Zero speed slip frequency settings	0.0-5.00Hz	1.00	●	110	0x716

F7.23	Torque control upper frequency limit selection	<p>LED "0" digit: Torque control upper frequency limit selection 0:FWD/REV set by [F0.11]. 1: FWD set by LED "00"digit; REV set by LED "000"digit. LED "00" digit: FWD upper frequency limit set 0:Torque control FWD upper frequency limit No set (F7.24) 1:Keyboard pot give 2:VS1 give 3:VS2 give 4:AS give 5:PUL give 6:RS485 give</p> <p>LED "000" digit: REV upper frequency limit set 0:Torque control REV upper frequency limit No set (F7.26) 1:Keyboard pot give 2:VS1 give 3:VS2 give 4:AS give 5:PUL give 6:RS485 give)</p>	0000	○	110	0x717
F7.24	Torque control FWD upper frequency limit No set	Lower limit-Max output frequency	50.00	○	111	0x718
F7.25	Torque control FWD upper frequency limit bias	0.0-20.0%	0.0	●	111	0x719
F7.26	Torque control REV upper frequency limit No set	Lower limit-Max output frequency	50.00	○	112	0x71A
F7.27	Torque control REV upper frequency limit bias	0.0-20.0%	0.0	●	112	0x71B
F7.28	Upper frequency limit under small torque	0.00-50.00Hz	3.00Hz	●	112	0x71C
F7.29	Small torque value threshold	0-200.0% 0:This function off	0.0%	●	112	0x71D

F7.30	Magnetic powder brake current give channel	<p>LED "0" digit: main channel selection 0: Keyboard give 1: Keyboard pot give or modify 2: VS1 give or modify 3: VS2 give or modify 4: AS give or modify</p> <p>LED "00" digit: Second channel selection 0: Keyboard give 1: Keyboard pot give or modify 2: VS1 give or modify 3: VS2 give or modify 4: AS give or modify</p> <p>LED "000" digit: Main channel combines second channel 0: Main × [F7.32] 1: Second × [F7.33] 2: Main × [F7.32] + second × [F7.33] 3: Main × [F7.32] - second × [F7.33] 4: MAX{Main × [F7.32], second × [F7.33]} 5: MIN{ Main × [F7.32], second × [F7.33]} LED "0000" digit: Reserved</p>	0010H	●	112	0x71E
F7.31	Magnetic powder brake current keyboard No give	0-200.0%	100.0%	●	113	0x71F
F7.32	Magnetic powder brake main channel gain	0-500.0%	100.0%	●	113	0x720
F7.33	Magnetic powder brake second channel gain	0-500.0%	100.0%	●	113	0x721

V/F control parameters

NO	Function description	Range of settings and definition	Factory setting	Attribute	Reference page	Communication add
F8.00	V/F curve selection	0: Beeline 1: User-defined V/F curve 2: 1.3 power falling torque curve 3: 1.7 power falling torque curve 4: 2.0 power falling torque curve	0	○	114	0x800
F8.01	Self-setting voltage V1	0.0%-100.0%	3.0%	○	114	0x801
F8.02	Self-setting frequency F1	0.0-max frequency	1.00Hz	○	114	0x802
F8.03	Self-setting voltage V2	0.0%-100.0%	28.0%	○	114	0x803
F8.04	Self-setting frequency F2	0.0-max frequency	10.00Hz	○	114	0x804
F8.05	Self-setting voltage V3	0.0%-100.0%	55.0%	○	114	0x805
F8.06	Self-setting frequency F3	0.0-max frequency	25.00Hz	○	114	0x806
F8.07	Self-setting voltage V4	0.0%-100.0%	78.0%	○	114	0x807
F8.08	Self-setting frequency F4	0.0-max frequency	37.50Hz	○	114	0x808
F8.09	Self-setting voltage V5	0.0%-100.0%	100.0%	○	114	0x809
F8.10	Self-setting frequency F5	0.0-max frequency	50.00Hz	○	114	0x80A
F8.11	Output voltage percentage	25-100%	100%	○	115	0x80B
F8.12	Torque boost	0.1%-30.0%	Accord model	○	115	0x80C
F8.13	Torque boost close	0.0%-100.0%	20.0%	○	115	0x80D
F8.14	V/F slip compensation	0.0-200.0%	0.0%	●	116	0x80E
F8.15	Auto energy-saving selection	0: no auto energy-saving 1: auto energy-saving	0	●	116	0x80F
F8.16	Lower frequency limit of energy-saving operation	0.0-500.0%	25.0%	●	116	0x810
F8.17	Energy-saving voltage down time	0.01-50.00s	10.00s	●	116	0x811
F8.18	Energy-saving voltage lowest limit	20.0-100.0%	50.0%	●	116	0x812
F8.19	ASR(VF) proportion gain1	0.0-100.00	1.00	●	116	0x813
F8.20	ASR(VF) integral time 1	0.01-10.00s	0.50s	●	116	0x814
F8.21	ASR(VF) filter time1	0.000-10.000s	0.005s	●	116	0x815
F8.22	ASR(VF) switch frequency 1	0.00-50.00Hz	5.00Hz	●	116	0x816
F8.23	ASR(VF) proportion gain 2	0.0-100.00	1.00	●	116	0x817

F8.24	ASR(VF) integral time 2	0.01-10.00s	0.50s	●	116	0x818
F8.25	ASR(VF) filter time 2	0.000-10.000s	0.100s	●	116	0x819
F8.26	ASR(VF) switch frequency 2	0.00-50.00Hz	10.00Hz	●	116	0x81A
F8.27	ASR(VF) slip limit	0.0-500.0%	100.0%	●	117	0x81B

Tension control special parameters

NO	Function description	Range of settings and definition	Factory setting	Attribute	Reference page	Communication add
F9.00	Tension setting selection	<p>LED "0" digit: main channel selection</p> <p>0: Keyboard No give</p> <p>1: Keyboard pot give or modify</p> <p>2: VS1 give or modify</p> <p>3: VS2 give or modify</p> <p>4: AS give or modify</p> <p>5: PUL give or modify</p> <p>6:RS485 give</p> <p>LED "00" digit: Second channel selection</p> <p>0: Keyboard give</p> <p>1: Keyboard pot give or modify</p> <p>2: VS1 give or modify</p> <p>3: VS2 give or modify</p> <p>4: AS give or modify</p> <p>5: PUL give or modify</p> <p>6:RS485 give</p> <p>LED "000" digit: Main channel combines second channel</p> <p>0: Main × [F9.01]</p> <p>1: Second × [F9.02]</p> <p>2: Main × [F9.01] + second × [F9.02]</p> <p>3: Main × [F9.01] - second × [F9.02]</p> <p>4: MAX{ Main × [F9.01], second × [F9.02]}</p> <p>5: MIN{ Main × [F9.01], second × [F9.02]}</p> <p>LED "000" digit: Reserved</p>	0000	●	117	0x900
F9.01	Tension give main channel gain	0-500.0%	100.0%	●	118	0x901
F9.02	Tension give second channel gain	0-500.0%	100.0%	●	118	0x902
F9.03	Tension No setting	0-30000N	0	●	118	0x903

F9.04	Max tension	0-30000N	0	●	118	0x904
F9.05	Tension tape coefficient	0.0-100.0%	0.0%	●	118	0x905
F9.06	Tape compensation modify	0-10000mm	0	●	119	0x906
F9.07	Reserved				119	0x907
F9.08	Reserved				119	0x908
F9.09	Machine drive ratio	0.01-300.00	1.00	●	119	0x909
F9.10	Curl mode	0: Winding (Roll diameter increase gradually) 1: Unwinding (Roll diameter decrease gradually)	0	●	119	0x90A
F9.11	Roll diameter calculation selection	0:Initial roll diameter, no calculate 1:Line speed calculate 2:Calculate through the accumulative thickness 3:Calculate through the time 4:Keyboard potentiometer give winding roll diameter 5:VS1 give winding roll diameter 6:VS2 give winding roll diameter 7: AS give winding roll diameter 8: PUL give winding roll diameter 9:RS485 give winding roll diameter	0	●	120	0x90B
F9.12	Max roll diameter	1-10000mm	500	●	120	0x90C
F9.13	Reel diameter	1-10000mm	100	●	120	0x90D
F9.14	Initial diameter resource selection	0: Terminal select 1: Keyboard potentiometer 2:VS1 3:VS2 4:AS 5:PUL	0	●	120	0x90E
F9.15	Initial diameter 1	1-10000mm	100	●	121	0x90F
F9.16	Initial diameter 2	1-10000mm	100	●	121	0x910
F9.17	Initial diameter 3	1-10000mm	100	●	121	0x911
F9.18	Diameter reset selection	0: Manual reset 1: Auto reset	0	●	121	0x912
F9.19	Diameter filter time	0.1-100.0s	1.0s	●	121	0x913
F9.20	Current roll diameter	1-10000mm	*	●	121	0x914
F9.21	Roll diameter calculate end frequency	0.00-50.00Hz	10.00	●	121	0x915
F9.22	Diameter reset delay	0-6000s	10	●	122	0x916

F9.23	Reserved				122	0x917
F9.24	Reserved				122	0x918
F9.25	Linear input resource	0:F9.28/F9.29 terminal selection 1: Keyboard potentiometer 2:VS1 3:VS2 4:AS 5:PUL(only for analog port use) 6:PUL*[F9.31]* π / [F9.32] 7:RS485 communication gives	0	●	122	0x919
F9.26	Max linear speed	0.0-6500.0m/Min	1000.0	●	122	0x91A
F9.27	Min linear speed of diameter calculate	0.0-6500.0m/Min	200.0	●	122	0x91B
F9.28	Linear speed setting 1	0.0-6500.0m/Min	1000.0	●	122	0x91C
F9.29	Linear speed setting 2	0.0-6500.0m/Min	1000.0	●	122	0x91D
F9.30	Current linear speed	0.0-6500.0m/Min	*	●	123	0x91E
F9.31	Traction roller diameter	0.0-1000.0mm	100.0 mm	●	123	0x91F
F9.32	Traction roller pulse per cycle	1-60000	1	●	123	0x920
F9.33	Reserved				123	0x921
F9.34	Reserved				123	0x922
F9.35	Reserved				123	0x923
F9.36	Pulse per cycle	1-60000	1	●	123	0x924
F9.37	Cycles per layer	1-10000	1	●	123	0x925
F9.38	Max thickness	0.01-100.00mm	1.00	●	123	0x926
F9.39	Material thickness set resource	0: F9.40/ F9.41 terminal select 1: Keyboard potentiometer 2:VS1 3:VS2 4:AS 5:PUL 6:RS485 communication gives	0	●	123	0x927
F9.40	Material thickness 1	0.01-100.00mm	0.01mm	●	124	0x928
F9.41	Material thickness 2	0.01-100.00mm	0.01mm	●	124	0x929
F9.42	Reserved				124	0x92A
F9.43	Reserved				124	0x92B
F9.44	Full roll diameter 1	1-10000mm	500	●	124	0x92C
F9.45	Full roll diameter 2	1-10000mm	500	●	124	0x92D
F9.46	Empty to full roll time 1	0-65000s	3600	●	124	0x92E

F9.47	Empty to full roll time 2	0-65000s	7200	●	124	0x92F
F9.48	Current time	0-65000s	*	●	124	0x930
F9.49	Reserved				124	0x931
F9.50	Reserved				124	0x932
F9.51	Reserved				124	0x933

Malfunction and protection parameters

NO.	Function description	Range of settings and definition	Factory setting	Attribute	Reference page	Communication add
FA.00	Protection function selection 1	LED "0" digit: ACC over-current protection selection 0: Invalid 1: Valid LED "00" digit: DEC over-current protection selection 0: Invalid 1: Valid LED "000" digit: current limit selection while running 0: Invalid 1: Valid LED "0000" digit: reserved	0001	●	125	0xA00
FA.01	Protection function selection 2	LED "0" digit: DEC over-voltage protection selection 0: Invalid 1: rating 1 over-voltage protection 2: rating 2 over-voltage protection LED "00" digit: RUN over-voltage protection selection 0: Invalid 1: Valid LED "000" digit: inverter over-load action selection 0: emergency stop output and alarm 1: emergency stop and alarm 2: limit current and run LED "0000" digit: motor over-load act 0: emergency stop output and alarm 1: emergency stop and alarm 2: limit current and run 3: motor over-load protection off	0001	●	125	0xA01

FA.02	Protection function selection 3	LED "0" digit: inverter OH protection selection 0: emergency stop output and alarm 1: emergency stop and alarm 2: limit current and run LED*00" digit: input phase lack protection selection 0: Invalid 1: Valid LED*000" digit: output phase lack protection selection 0: Invalid 1: Valid LED*0000" digit: reserved	0110	●	126	0xA02
FA.03	Protection function selection 4	LED "0" digit: SC protection selection 0: Invalid 1: Valid LED*00" digit: OC protection selection 0: Invalid 1: Valid LED*000" digit: reserved LED*0000" digit: reserved	0000	●	127	0xA03
FA.04	Fan control	0: Fan runs after electrifying 1: Fan stop related to temperature and work while running 2: Fan stop while machine stop and run related to temperature	1	●	127	0xA04
FA.05	DEC over-voltage inhibition point	110-150%	120%	●	127	0xA05
FA.06	Running over-voltage inhibition point	100-150%	115%	●	127	0xA06
FA.07	OV protection max frequency add	0-50.00Hz	2.00Hz	●	127	0xA07
FA.08	Energy braking action voltage	115.0%-140.0%	120.0%	●	128	0xA08
FA.09	Reserved			●	128	0xA09
FA.10	Bus under-voltage protection	50.0%-100.0%	60.0%	●	128	0xA0A
FA.11	Speed fall act voltage at sudden power down	0-200%	20%	●	128	0xA0B
FA.12	Main circuit aim voltage at sudden power down	0%-200%	90%	●	128	0xA0C
FA.13	Speed fall gain at sudden power down	0.01-10.00	2.00	●	128	0xA0D

FA.14	Speed back waiting time at sudden power down	0.01-100.00s	2.0s	●	128	0xA0E
FA.15	ACC OC protection point	100-250%	160%	●	128	0xA0F
FA.16	DEC OC protection point	100-250%	160%	●	128	0xA10
FA.17	Current limit level while running	100-250%	160%	●	128	0xA11
FA.18	Current limit frequency ACC/DEC time while running	0.00-650.00s	10.00s	●	128	0xA12
FA.19	OV protection respond gain	0-10.0	0.2	○	129	0xA13
FA.20	Reserved				129	0xA14
FA.21	Motor overload protection current	20.0%-120.0%	100.0%	●	129	0xA15
FA.22	Malfunction recovery times	0-5	0	●	129	0xA16
FA.23	Malfunction auto-reset interval	0.1-100.0s	1.0s	●	129	0xA17
FA.24	Reserved				129	0xA18
FA.25	Malfunction types	Please see malfunction code table	--	×	129	0xA19
FA.26	Malfunction running frequency	0.00-max frequency	--	×	129	0xA1A
FA.27	Malfunction output voltage	0-1500v	--	×	129	0xA1B
FA.28	Malfunction output current	0.1-100.0s	--	×	129	0xA1C
FA.29	Malfunction bus voltage	0-3000V	--	×	129	0xA1D
FA.30	Malfunction module temperature	0-100°C	--	×	129	0xA1E
FA.31	Malfunction machine state	LED "0" digit: run direction 0: FWD 1: REV LED "00" digit: run state 0: stop 1: stable speed 2: ACC 3: DEC LED "000" digit: reserved LED "0000" digit: reserved	--	×	129	0xA1F
FA.32	Malfunction input terminal state	See input terminal chart	--	×	130	0xA20

FA.33	Malfunction output terminal state	See input terminal chart	--	×	130	0xA21
FA.34	The last malfunction types	Please see malfunction code table		×	130	0xA22
FA.35	The last malfunction running frequency	0.00-max frequency	--	×	130	0xA23
FA.36	The last malfunction output voltage	0-1500v	--	×	130	0xA24
FA.37	The last malfunction output current	0.0-2000.0A	--	×	130	0xA25
FA.38	The last malfunction bus voltage	0-3000V	--	×	130	0xA26
FA.39	The last malfunction module temperature	0-100°C	--	×	130	0xA27
FA.40	The last machine state	LED "0" digit: run direction 0: FWD 1: REV LED "00" digit: run state 0: stop 1: stable speed 2: ACC 3: DEC LED "000" digit: reserved LED "0000" digit: reserved	--	×	130	0xA28
FA.41	The last malfunction input terminal state	See input terminal chart	--	×	130	0xA29
FA.42	The last malfunction output terminal state	See input terminal chart	--	×	130	0xA2A
FA.43	The first two malfunction types	Please see malfunction code table	--	×	130	0xA2B
FA.44	The first three malfunction types	Please see malfunction code table	--	×	130	0xA2C

PID process control parameters

NO.	Function description	Range of settings and definition	Factory setting	Attribute	Reference page	Communication add
Fb.00	PID given signal source	0: Keyboard number giving PID 1: Keyboard potentiometer 2: Terminal VS1 voltage analog 3: Terminal VS2 voltage analog 4: Terminal AS current analog 5: Terminal PUL pulse signal 6: RS485 communication 7: Optional card	0	○	132	0xB00
Fb.01	Keyboard digit given PID	0.00-100.0	50.0%	●	133	0xB01
Fb.02	PID feedback signal source	0: Keyboard digit PID given 1: Keyboard potentiometer given 2: Terminal VS1 voltage analog given 3: Terminal VS2 voltage analog given 4: Terminal AS current analog given 5: Terminal PUL pulse signal given 6: RS485 communication given 7: Optional card	2	○	133	0xB02
Fb.03	Feedback signal gain	0.00-10.00	1.00	●	134	0XB03
Fb.04	Feedback signal max measuring range	0-100.0	100.0	●	134	0xB04
Fb.05	PID control selection	LED "0"digit: feedback trait selection 0: Positive trait 1: Negative trait LED "10"digit: PID adjust direction selection 0:reverse forbidden 1:reverse allowed LED "100"digit: error of center-aligned selection 0:invalid 1: valid LED "1000"digit: the second PID valid range selection 0: terminal choice is valid 1:terminal choice and drop-in error range are valid	0100	○	134	0xB05
Fb.06	PID preset frequency	0.00-Max frequency	50.00Hz	●	135	0xB06
Fb.07	PID preset frequency running time	0.0-6500.0	0.0s	●	135	0xB07
Fb.08	Proportion gain P1	0.00-100.00	1.00	●	135	0xB08
Fb.09	Integral time I1	0.01-10.00s	0.10s	●	135	0xB09

Fb.10	Differential coefficient D1	0.00-10.00s	0.00s	●	135	0xB0A
Fb.11	Sample cycle	0.01-100.00s	0.10s	●	136	0xB0B
Fb.12	PID control deviation limitation	0.0-100.0%	0.0%	●	136	0xB0C
Fb.13	Reserved	0.0-100.0%			136	0xB0D
Fb.14	Detection time while feedback wire break	0.0-6500.0s	1.0s	●	136	0xB0E
Fb.15	Action selections while feedback wire break	0: Go on PID operation without alarm 1: Stop and alarm malfunction 2: Go on PID operation and output alarm signal 3: Run at the current frequency and output alarm signal	0	●	136	0xB0F
Fb.16	Wire break alarm upper limit	0.0-100.0%	100.0%	●	136	0xB10
Fb.17	Wire break alarm lower limit	0.0-100.0%	0.0%	●	136	0xB11
Fb.18	Constant pressure water supply sleep system selection	0: Invalid 1: Valid	0	●	137	0xB12
Fb.19	Start-up threshold	0.0-100.0%	0.0%	●	137	0xB13
Fb.20	Dormancy threshold	0.0-100.0%	0.900	●	137	0xB14
Fb.21	Dormancy sense DEC time	0-6500.0s	30.0s	●	137	0xB15
Fb.22	Stop sense low bit hold frequency	0-20.00Hz	10.00Hz	●	137	0xB16

Multi-step, PLC function and swing frequency parameters

NO.	Function description	Range of settings and definition	Factory setting	Attribute	Reference page	Communication add
FC.00	PLC Step 1	0.00-320.00Hz	10.00Hz	●	137	0xC00
FC.01	PLC Step 2	0.00-320.00Hz	20.00Hz	●	137	0xC01
FC.02	PLC Step 3	0.00-320.00Hz	30.00Hz	●	137	0xC02
FC.03	PLC Step 4	0.00-320.00Hz	40.00Hz	●	137	0xC03
FC.04	PLC Step 5	0.00-320.00Hz	50.00Hz	●	137	0xC04
FC.05	PLC Step 6	0.00-320.00Hz	40.00Hz	●	137	0xC05
FC.06	PLC Step 7	0.00-320.00Hz	30.00Hz	●	137	0xC06
FC.07	PLC Step 8	0.00-320.00Hz	20.00Hz	●	137	0xC07
FC.08	PLC Step 9	0.00-320.00Hz	10.00Hz	●	137	0xC08
FC.09	PLC Step 10	0.00-320.00Hz	20.00.H	●	137	0xC09
FC.10	PLC Step 11	0.00-320.00Hz	30.00Hz	●	137	0xC0A
FC.11	PLC Step 12	0.00-320.00Hz	40.00Hz	●	137	0xC0B
FC.12	PLC Step 13	0.00-320.00Hz	50.00Hz	●	137	0xC0C

FC.13	PLC Step 14	0.00-320.00Hz	40.00Hz	●	137	0xC0D
FC.14	PLC Step 15	0.00-320.00Hz	30.00Hz	●	137	0xC0E
FC.15	PLC running Mode selection	<p>LED"0"digit: 0: Stop after single cycle 1: Continuous cycles 2: Keep final value after single cycle</p> <p>LED"10"digit: Time unit 0: second 1: minute 2: hour</p> <p>LED"100"digit: Power down memory mode 0: no saved 1: save</p> <p>LED"1000"digit: Start-up mode 0: Restart from the 1st step 1: Restart from the stop stage 2: Continue from the time when stop</p> <p>LED"0000"digit: Start-up mode 0: Restart from the 1st step 1: Restart from the step where stop 2: Restart from the time when stop</p>	0000	●	139	0xC0F
FC.16	PLC 1st step running time	0.0-6500.0(s/m/h)	10.0	●	140	0xC10
FC.17	PLC 2nd step running time	0.0-6500.0(s/m/h)	10.0	●	140	0xC11
FC.18	PLC 3rd step running time	0.0-6500.0(s/m/h)	10.0	●	140	0xC12
FC.19	PLC 4th step running time	0.0-6500.0(s/m/h)	10.0	●	140	0xC13
FC.20	PLC 5th step running time	0.0-6500.0(s/m/h)	10.0	●	140	0xC14
FC.21	PLC 6th step running time	0.0-6500.0(s/m/h)	10.0	●	140	0xC15
FC.22	PLC 7th step running time	0.0-6500.0(s/m/h)	10.0	●	140	0xC16
FC.23	PLC 8th step running time	0.0-6500.0(s/m/h)	10.0	●	140	0xC17
FC.24	PLC 9th step running time	0.0-6500.0(s/m/h)	10.0	●	141	0xC18

FC.25	PLC 10th step running time	0.0-6500.0(s/m/h)	10.0	●	141	0xC19
FC.26	PLC 11th step running time	0.0-6500.0(s/m/h)	10.0	●	141	0xC1A
FC.27	PLC 12th step running time	0.0-6500.0(s/m/h)	10.0	●	141	0xC1B
FC.28	PLC 13th step running time	0.0-6500.0(s/m/h)	10.0	●	141	0xC1C
FC.29	PLC 14th step running time	0.0-6500.0(s/m/h)	10.0	●	141	0xC1D
FC.30	PLC 15th step running time	0.0-6500.0(s/m/h)	10.0	●	141	0xC1E
FC.31	PLC 1 st step direction and ADD/DEC time	<p>LED "0" digit: this step run direction 0: FWD 1: REV LED "00" digit: ACC/DEC time in this step 0: ACC/DEC time 1 1: ACC/DEC time 2 2: ACC/DEC time 3 4: ACC/DEC time 4 LED "000" digit: reserved LED "0000" digit: reserved</p>	0000	●	141	0xC1F
FC.32	PLC 2 nd step direction and ADD/DEC time		0000	●	141	0xC20
FC.33	PLC 3 rd step direction and ADD/DEC time		0000	●	141	0xC21
FC.34	PLC 4 th step direction and ADD/DEC time		0000	●	141	0xC22
FC.35	PLC 5 th step direction and ADD/DEC time		0000	●	141	0xC23
FC.36	PLC 6 th step direction and ADD/DEC time		0000	●	141	0xC24
FC.37	PLC 7 th step direction and ADD/DEC time		0000	●	141	0xC25
FC.38	PLC 8 th step direction and ADD/DEC time		0000	●	141	0xC26
FC.39	PLC 9 th step direction and ADD/DEC time		0000	●	141	0xC27
FC.40	PLC 10 th step direction and ADD/DEC time		0000	●	141	0xC28
FC.41	PLC 11 th step direction and ADD/DEC time		0000	●	141	0xC29
FC.42	PLC 12 th step direction and ADD/DEC time		0000	●	141	0xC2A
FC.43	PLC 13 th step direction and ADD/DEC time		0000	●	141	0xC2B
FC.44	PLC 14 th step direction and ADD/DEC time		0000	●	141	0xC2C

FC.45	PLC 15 th step direction and ADD/DEC time		0000	●	141	0xC2D
FC.46	Reserved				141	0xC2E
FC.47	Reserved				141	0xC2F
FC.48	Swing frequency control	LED "0" digit: swing frequency control 0: invalid 1: valid LED "00" digit: swing frequency get in mode 0: Automatic 1: manual LED "000" digit: AW control 0: variable 1: fixed LED "0000" digit: reserved	0000	○	141	0xC30
FC.49	Swing frequency pre-set	0.0-max frequency	0.00Hz	●	141	0xC31
FC.50	Pre-set frequency hold time	0.00-650.00s	0.00s	●	141	0xC32
FC.51	Swing frequency range	0.0-100.0%	0.0%	●	141	0xC33
FC.52	Jumping frequency amplitude	0.0-50.0%	0.0%	●	141	0xC34
FC.53	Swing frequency ACC time	0.00-650.00s	5.00s	●	142	0xC35
FC.54	Swing frequency DEC time	0.00-650.00s	5.00s	●	142	0xC36

Communication control function parameters

NO.	Function description	Range of settings and definition	Factory setting	Attribute	Reference page	Communication add
Fd.00	Main-slave machine selection	0: Main machine 1: Slave machine	0	○	143	0xD00
Fd.01	Machine add	1-247	1	○	143	0xD01
Fd.02	Communication baud rate selection	0: 1200 bps 1: 2400 bps 2: 4800 bps 3: 9600 bps 4: 19200 bps 5: 38400 bps	3	○	143	0xD02
Fd.03	Data format	0: (N,8,1) no checkout, Data digit: 8, Stop digit: 1	0	○	143	0xD03

Fd.03	Data format	<p>1: (E,8,1) even checkout, Data digit: 8, Stop digit: 1</p> <p>2: (O,8,1) odd checkout, Data digit: 8, Stop digit: 1</p> <p>3: (N,8,2) no checkout, Data digit: 8, Stop digit: 2</p> <p>4: (E,8,2) even checkout, Data digit: 8, Stop digit: 2</p> <p>5: (O,8,2) odd checkout, Data digit: 8, Stop digit: 2</p>	0	○	143	0xD03
Fd.04	Communication ratio setting	0.00-5.00	1.00	●	143	0xD04
Fd.05	Communication answer delay	0-500ms	0ms	●	143	0xD05
Fd.06	Communication overtime time	0.1-100.0s	1.0s	●	144	0xD06
Fd.07	RS485 communication fault action mode selection	<p>0: Alarm and stop freely</p> <p>1: Not alarm, go on run</p> <p>2: Stop without alarm</p>	1	●	144	0xD07
Fd.08	Transmission response dispose	<p>0: Write operation with response</p> <p>1: Write operation without response</p>	0	●	144	0xD08
Fd.09	Main machine sending selection	<p>LED*0"digit: the first group of transmit frame selection</p> <p>0: Invalid</p> <p>1: Run command given</p> <p>2: Main machine given</p> <p>3: Main machine output frequency</p> <p>4: Main machine upper limit frequency</p> <p>5: Main machine given torque</p> <p>6: Main machine output torque</p> <p>7: Reserved</p> <p>8: Reserved</p> <p>9: Main machine given PID</p> <p>A: Main machine feedback PID</p> <p>LED*10"digit: the second group of transmit frame selection Ditto</p> <p>LED*100"digit: the third group of transmit frame selection Ditto</p> <p>LED*1000"digit: the fourth group of transmit frame selection Ditto</p>	0031	●	144	0xD09

Monitor code

NO.	Function name	Range of settings and definition	Communication add
C-00	Given frequency	0.01Hz	2100H
C-01	Output frequency	0.01Hz	2101H
C-02	Output current	0.1A	2102H
C-03	Input voltage	0.1V	2103H
C-04	Output voltage	0.1V	2104H
C-05	Machine speed	RPM	2105H
C-06	Set torque	0.1%	2106H
C-07	Output torque	0.1%	2107H
C-08	PID given	0.1%	2108H
C-09	PID feedback	0.1%	2109H
C-10	Output power	0.1%	210AH
C-11	Bus voltage	0.1V	210BH
C-12	Module temperature 1	0.1℃	210CH
C-13	Module temperature 2	0.1℃	210DH
C-14	Input terminal X on-state	refer to diagram x	210EH
C-15	Output terminal Y on-state	refer to diagram x	210FH
C-16	Analog VS1 input	0.001V	2110H
C-17	Analog VS2 input	0.001V	2111H
C-18	Analog AS input	0.001mA	2112H
C-19	Impulse single PUL input	0.001kHz	2113H
C-20	Analog output AO1	0.01V	2114H
C-21	Analog output AO2	0.01V/0.01mA/0.01kHz	2115H
C-22	Counting value of counter		2116H
C-23	Running time after electrify(of this time)	Hour	2117H
C-24	Local accumulative running time	0.1h	2118H
C-25	Inverter power class	kW	2119H
C-26	Inverter rated voltage	V	211AH
C-27	Inverter rated current	A	211BH
C-28	Software edition		211CH
C-29	PG feedback frequency	0.01Hz	211DH

10.2 Appendix 2: RS485 communication protocol

● Communication protocol

The AC90 series frequency inverter can select the RS485 communication interface. The ModBus communication protocol of international standard is adopted for master-slave communication. The consumer can carry out centralized control by PC/PLC, upper machine, main station frequency inverter etc (Setting of the frequency inverter control command, running frequency, relative function parameters modification, frequency inverter working state and malfunction information monitoring etc.) to adapt to the special application requirements.

● Application styles

1. AC90 series frequency inverter is connected to "single host and many slave machines" control network with RS232/RS485 master line. Slave machine do not response while main machine order with broadcast (while slave machine add is 0).
2. AC90 afford RS485 port only, asynchronous half-duplex. While the communication port of the external equipment is RS232, RS232/RS485 converter should be added.
3. This ModBus serial communication protocol defines asynchronous transfer information content and formats used in the serial communication, which can be divided into RUT and ASCII mode. AC90 is RTU (remote terminal unit) mode.

● Communication frame structure

Communication data format is as follows:

The byte composition: Include initiation bit, 8 data bit, check bit and stop bit.

initiation bit	Bit1	Bit2	Bit3	Bit4	Bit5	Bit6	Bit7	Bit8	check bit	stop bit
----------------	------	------	------	------	------	------	------	------	-----------	----------

One frame message must be transmitted as a continued data flow, if there is a pause over 1.5 byte before the end. The receiving equipment will clear the half-baked information. And the next byte will be considered as the address domain of a new frame. Similarly, if the interval between a new frame start-up and the former frame is smaller than 3.5 byte time, the receiving equipment will think that it is the former one frame continuation. Because of the jumbled frame, finally CRC checking value is incorrect, what leads to the communication mistake.

RTU frame's standard structure:

Frame START	Transmission time of 3.5 bytes
Slave machine address	Communication address: 0~247 (decimal) (0 is broadcast address)
Function code	03H: read slave machine parameter 06H: write slave machine parameter 08H: circuit auto-detection
Data domain	parameter address, parameter number, parameter values
CRC CHK low-order	Detecting value: 16 bit CRC Detecting value
CRC CHK high-order	
Frame ending	transmission time of 3.5 bytes

In RTU mode, it always begins with transmission time pause gap of at least 3.5 bytes. The successive order of the following transmission data domains: slave machine address, operation command code, data and CRC checking bit. Transmission byte of each domain is sexadecimal 0...9; A...F. Network equipment detects the network bus unceasingly, including the pause gap time. While receiving the first domain (address information), each network equipment carries out decoding to judge whether the byte is sent to it. While the final byte transmission is completed, there will be an at least 3.5 bytes transmission time pause gap to indicate that this frame is over. Then a new information' transmission

can begin.

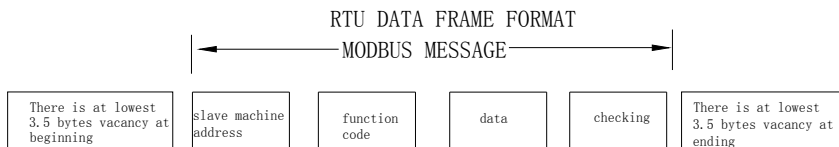

● Command code and communication data description

For example: The frequency inverter whose slave machine address is 01H, memory initial address is 2100H [(C-00)], read continuously 3 words, then the structure of that frame is described as follows:

RTU host machine command information

START	Transmission time of 3.5 bytes
Slave machine address	01H
Command code	03H
Start address high-order	21H
Start address low-order	00H
Data number high-order	00H
Data number low-order	03H
CRC CHK low-order	0FH
CRC CHK high-order	F7H
END	Transmission time of 3.5 bytes

RTU Slave machine responding information (normal)

START	Transmission time of 3.5 bytes
Slave machine address	01H
Command code	03H
Byte number low-order	06H
Data address 2100H high-order	13H
Data address 2100H low-order	88H
Data address 2101H high-order	00H
Data address 2101H low-order	00H
Data address 2102H high-order	00H
Data address 21021H low-order	00H
CRC CHK low-order	90H
CRC CHK high-order	A6H
END	Transmission time of 3.5 bytes

Slave machine responding information (abnormal)

START	Transmission time of 3.5 bytes
Slave machine address	01H
Command code	03H
Error code	04H
CRC CHK low-order	21H
CRC CHK high-order	33H
END	Transmission time of 3.5 bytes

Command code: 06H, write a word (Word)

Function: write a word data in the designated data address. It can be used to revise the frequency inverter parameters.

For instance: 5000 (1388 H) is written into the 3000H address of slave frequency inverter with address 1. Then the structure of this frame is described as follows:

RTU host machine order information

START	Transmission time of 3.5 bytes
Slave machine address	01H
Command code	06H
Write data address high-order	30H
Write data address low-order	00H
Data content high-order	13H
Data content low-order	88H
CRC CHK low-order	8BH
CRC CHK high-order	9CH
EBD	Transmission time of 3.5 bytes

RTU Slave machine responding information (normal)

START	Transmission time of 3.5 bytes
Slave machine address	01H
Command code	06H
Write data address high-order	30H
Write data address low-order	00H
Data content high-order	13H
Data content low-order	88H
CRC CHK low-order	8BH
CRC CHK high-order	9CH
EBD	Transmission time of 3.5 bytes

RTU Slave machine responding information (abnormal)

START	Transmission time of 3.5 bytes
Slave machine address	01H
Command code	86H
Error code	01H
CRC CHK low-order	83H
CRC CHK high-order	A0H
END	Transmission time of 3.5 bytes

Command code: 08H, circuit auto-detection

Function: Send back the slave machine responding information which is identical with the host machine command information. It is used to check whether the signal transmission between the host machine and slave machine is regular or not. The checking code and the data can be set freely.

RTU Host machine command information

START	Transmission time of 3.5 bytes
Slave machine address	01H
Command code	08H
Detecting code high-order	00H
Detecting code low-order	00H
Data high-order	13H
Data low-order	88H
CRC CHK low-order	EDH
CRC CHK high-order	5DH
END	Transmission time of 3.5 bytes

RTU Slave machine responding information (normal)

START	Transmission time of 3.5 bytes
Slave machine address	01H
Command code	08H
Detecting code high-order	00H
Detecting code low-order	00H
Data high-order	13H
Data low-order	88H
CRC CHK low-order	EDH
CRC CHK high-order	5DH
END	Transmission time of 3.5 bytes

RTU Slave machine responding information (abnormal)

START	Transmission time of 3.5 bytes
slave machine address	01H
Command code	88H
Error code	03H
CRC CHK low-order	06H
CRC CHK high-order	01H
END	Transmission time of 3.5 bytes

Communication frame error check mode

The standard ModBus serial network adopts two kinds of error check mode: odd/even checking which is used to check every character and CRC detecting which is used to check one frame of data.

1. Odd-even checking

The users can configure the controller with odd or even checking, or no checking, what will determine how to set odd/even checking in every character.

If odd /even checking have been allocated, "1" bit will be accounted to the bit number of each character (7 bits in ASCII mode, 8 bits in RTU). For instance, the RTU character frame contains the following 8 bits: 1 1 0 0 0 1 0 1

There are 4 bits with number"1". If using the even checking, odd/even checking bit of the frame will be 0, then there are still 4 bits with number"1". If using odd checking, odd/even checking bit of the frame will be 1, then there are 5 bits with number"1".

If odd/even checking has not been allocated, there will be no checking bit during the transmission, and no checking detection. One additional stop bit will be filled into the character frame in transmission.

2. CRC-16 (cycle redundant check)

While the RTU frame form in use; the frame has included the frame error detecting domain which calculates base on the CRC method. The CRC domain checks the content of the entire frame. The CRC domain is two bytes, containing binary values of 16 bits. It is added to the frame after calculated by the transmission equipment. The receiving equipment calculates CRC who receives frame again, and compares it with the value of the receiving CRC domain. If both CRC value are not equal, it means the transmission has mistake.

CRC is firstly stored in 0xFFFF. Then a program is used to process the continuous 6 or above bytes in the frame and the value of current registers. Only 8Bit in every character is valid to CRC. Start bit、stop bit and parity check bit are invalid.

In the process of CRC coming out, each 8 characters independently XOR with register content. The result moves to lowest effective bit, and then the highest effective bit is filled with "1". LSB is extracted to be detected. If LSB is 1, he register independently XOR with the preset value. If LSB is 0, don't need XOR. This entire process needs to repeat 8 times. After the last bit (the eighth bit) is accomplished, next 8 bits byte will independently XOR with register content. All the final bytes in the frame are CRC value after processed.

This CRC operation method adopts the international standard CRC checking rule. Users can consult the relevant standard CRC operation while editing the CRC algorithm to compile out the CRC calculation program which is really meet the requirements.

Now here provide the user a simple CRC operation function (with C language programming):

```
unsigned int crc_chk_value(unsigned char *data_value, unsigned char length)
```

```
{
    unsigned int crc_value=0xFFFF;
    int i;
    while(length--)
    {
        crc_value^=*data_value++;
        for(i=0;i<8;i++)
        {
            if(crc_value&0x0001)
            {
                crc_value=(crc_value>>1)^0xa001;
            }
            else
            {
                crc_value=crc_value>>1;
            }
        }
    }
    return(crc_value);
}
```

●Communication data address definition

This part is the address definition of communication data. It is used to control the frequency inverter running and fetch frequency inverter mode information and frequency inverter relevant function parameter setting.

(1)AC90 serial function parameter address express rules

Take frequency inverter function parameter serial numbers as register address which are divided into the high byte and the low byte two parts. The high byte expresses the function parameter group serial numbers. The low byte expresses the inner serial numbers of each function parameter group. All need to be changed to hexadecimal.

Address domain high byte definition:

Parameter code no	Head add of this group of parameter
F0 basic function parameter	0x0000 (not save in to EEPROM) 0x1000 (save in to EEPROM)
F1 running control parameter	0x0100 (not save in to EEPROM) 0x1100 (save in to EEPROM)
F2 quantum digital terminal parameter	0x0200 (not save in to EEPROM) 0x1200 (save in to EEPROM)
F3 quantum analog terminal parameter	0x0300 (not save in to EEPROM) 0x1300 (save in to EEPROM)
F4 keyboard and display parameter	0x0400 (not save in to EEPROM) 0x1400 (save in to EEPROM)
F5 motor parameter	0x0500 (not save in to EEPROM) 0x1500 (save in to EEPROM)
F6 VC control parameter	0x0600 (not save in to EEPROM) 0x1600 (save in to EEPROM)
F7 torque control parameter	0x0700 (not save in to EEPROM) 0x1700 (save in to EEPROM)
F8 V/F control parameter	0x0800 (not save in to EEPROM) 0x1800 (save in to EEPROM)
F9 plus function parameter	0x0900 (not save in to EEPROM) 0x1900 (save in to EEPROM)
FA malfunction protection parameter	0x0A00 (not save in to EEPROM) 0x1A00 (save in to EEPROM)
Fb PID control parameter	0x0B00 (not save in to EEPROM) 0x1B00 (save in to EEPROM)
FC multistep and PLC parameter	0x0C00 (not save in to EEPROM) 0x1C00 (save in to EEPROM)
Fd communication function parameter	0x0D00 (not save in to EEPROM) 0x1D00 (save in to EEPROM)
FE reserved	0x0E00 (not save in to EEPROM) 0x1E00 (save in to EEPROM)
FF reserved	0x0F00 (not save in to EEPROM) 0x1F00 (save in to EEPROM)
C monitor parameter	0x2100
Communication control parameter	0x3000 or 0x2000

Attention: because it is possible that the parameters are frequently rewritten exists in the communication, EEPROM are stored frequently. So its lifetime is cut down. As for the consumer, some function is unnecessary to store in the

communication mode, only changing the value of RAM inner can satisfy the usage requirement. As AC90 communication protocol stipulates to use writing order (06 H), if the parameter function code address domain highest digit is 0, merely it write in the frequency inverter RAM, power down without storage, if the parameter function code address high half digit is 1, it write in EEPROM, namely power off with storage.

For instance, rewriting the function parameter **[F0.14]**, not depositing to EEPROM, address expresses for 000EH, depositing to EEPROM, address expresses for 100EH.

(2) Communication control parameter address specification:

Function declaration	Address definition	Data meaning specification	R/W characteristic
Communication given frequency	0x3000 or 0x2000	0~40000 is corresponding to 0.00Hz~400.00Hz	W/R
Communication order setting	0x3001 or 0x2001	0000H: No order	W
		0001H: FWD running	
		0002H: REV running	
		0003H: FWD jog	
		0004H: REV jog	
		0005H: speed-down stop	
		0006H: freely stop	
Frequency inverter state	0x3002 or 0x2002	Bit0 0: stop 1:running	R
		Bit1 0: no ACC 1: ACC	
		Bit2 0: no DEC 1: DEC	
		Bit3 0: FWD 1: REV	
		Bit4 0:inverter normal 1:inverter fault	
Frequency inverter fault code	0x3003 or 0x2003	current frequency inverter fault code (refer to fault code table)	R/W
Communication given upper frequency	0x3004 or 0x2004	0~40000 is corresponding to 0.00Hz~400.00Hz	W
Communication given torque setting	0x3005 or 0x2005	0~2000 is corresponding to 0.0~200.0%	W
Communication given max frequency in torque control FWD	0x3006 or 0x2006	0~2000 is corresponding to 0.0~200.0%	W
Communication given max frequency in torque control REV	0x3007 or 0x2007	0~2000 is corresponding to 0.0~200.0%	W
Communication given PID setting	0x3008 or 0x2008	0~1000 is corresponding to 0.0~100.0%	W
Communication given PID feedback	0x3009 or 0x2009	0~1000 is corresponding to 0.0~100.0%	W

10.3 Appendix 3: PG card manual

1. Summarize

AC80PG feedback card is mainly used for VC frequency inverter feedback of motor speed and direction detection signal to achieve higher accuracy of motor speed and direction control.

2. Model and technical parameter

2.1 Model

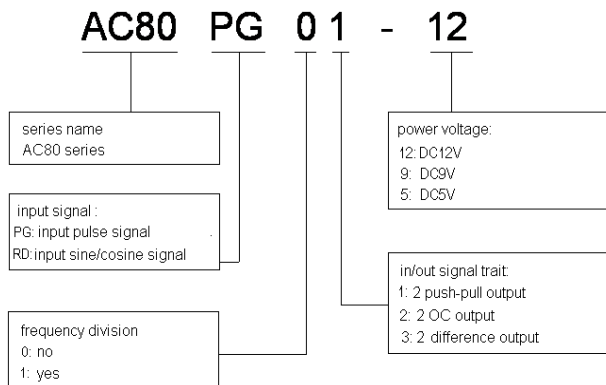

2.2 Parameters

model	power	input signal trait		output signal trait	
		response frequency range	Input impedance	output frequency range	output current
AC80PG01-12 AC80PG02-12 AC80PG03-12	12V±5% 200mA	0~80KHz	About 1kΩ	0~80KHz No frequency division	≤100mA



3. Terminal function

3.1 Main signal terminal function



Terminal name	Function
O_A	Push-pull output A signal
O_B	Push-pull output B signal
GND	Output signal power earth
+12V GND	+12V output power (power for encoder)
A+	Difference input A+ signal
A-	Difference input A- signal
B+	Difference input B+ signal
B-	Difference input B- signal

3.2 Optional terminal function

Function name	Selected position	Picture	Function
Optional terminal for track signal channel	J4 J6		Select J4 J6 for outside track (while using optional PG card)
	J5 J7		Select J5 J7 for inner track

4. Installation size

4.1 Installation show

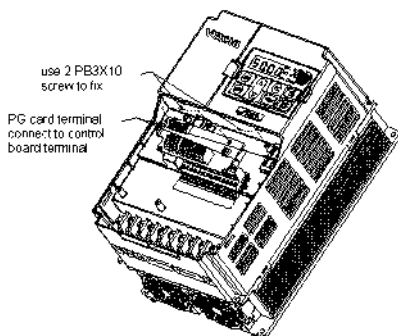

4.2 Installation size

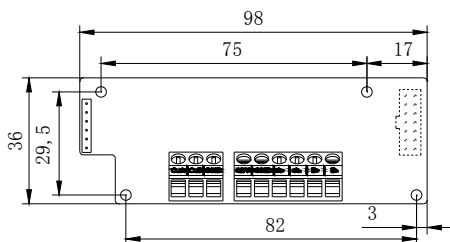

5. Electric connect and using

5.1 Whole machine wiring

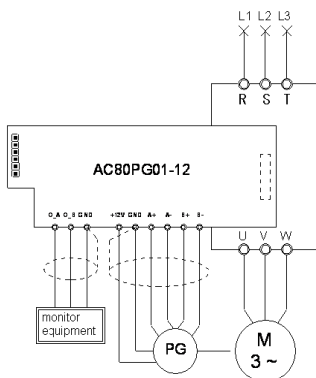

5.2 Application wiring

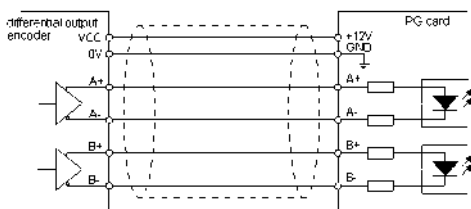

5.2.1 Differential output encoder wiring

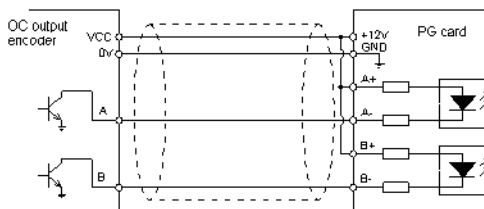

5.2.2 OC output encoder wiring

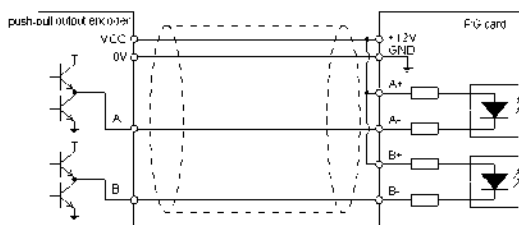

5.2.3 Push-pull output encoder wiring